

MANUAL DE ICONOGRAFÍA

ELEMENTOS GRÁFICOS DEL
PATRIMONIO LOCAL Y NATURAL

Desarrollo de un Sistema de Innovación
para la Producción Artesanal de
Cerámica ofertada por INTERCRAFTS
PERÚ, basada en laboratorios
Experimentales N101
-FICYT-FIDECOM-PIPEA 2011



Investigación, recopilación y edición
Pilar Kukurelo

Ilustraciones
Wladimir Castañeda

Digitalización
Laura Alvares

Diseño Gráfico y diagramación
Jessica Morón

Setiembre 2013

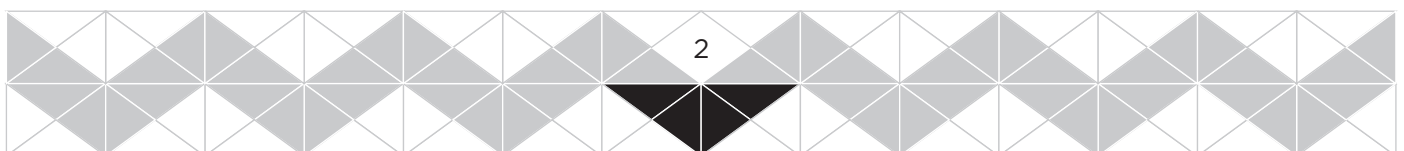

5	Introducción
	Cultura prehispánica
12	1.1 Huari Cerámica Textil
24	1.2 Pachacamac Textil Madera
27	1.3 Ychma Cerámica
28	1.4 Puruchuco Cerámica Textil
	Periodo Colonial
32	2.1 Arquitectura civil
39	2.2 Arquitectura religiosa
	Naturaleza
50	Pampa de la Quinua

Introducción

El presente manual se realiza en el marco del proyecto PIPEA 101-2011 Desarrollo de un Sistema de Innovación para la Producción Artesanal de Cerámica ofertada por INTERCRAFTS PERÚ, basada en laboratorios Experimentales.

La investigación de los elementos iconográficos Huari toma como base el proyecto AXIS Huari: generación de un modelo de análisis formal bi y tridimensional para el estudio en profundidad de patrones de iconografía prehispánica y colonial de Ayacucho, realizado por la autora en el año 2012 en la Pontificia Universidad Católica del Perú.

La metodología y estrategia de investigación para este Manual contempló el Registro de imágenes en fuentes primarias:

- Visita a Museos de Sitio de Puruchuco, Pachacamac, Museo Nacional de Arqueología, Antropología e Historia.
- Visita de campo a la ciudad de Ayacucho para el registro de arquitectura civil y religiosa.

Así mismo el Registro de imágenes en fuentes secundarias: búsqueda bibliográfica, búsqueda en Web.

Las imágenes han sido organizadas en dos grandes grupos: los referentes arquitectónicos y los referentes arqueológicos. Se ha considerado para esta selección los referentes que se vinculan a las asociaciones artesanales: Ichimay Wari y Tawaq, ubicadas en Lurín y Ate respectivamente. Ambas asociaciones están conformadas por artesanos que proceden de Ayacucho. Es por ello que se ha considerado como punto de partida el patrimonio arquitectónico y arqueológico del lugar de origen (Huamanga) y los referentes de los nuevos emplazamientos de dichas asociaciones: Pachacamac y Puruchuco.

El presente manual es un insumo que busca aportar a la producción artesanal en cerámica del país, recuperando las fuentes originales y poniendo al alcance de los productores imágenes que les son propias como parte de su legado, herencia y tradición.

Es un paso más en un proceso de investigación constante de las fuentes prehispánicas que se siguen descubriendo día a día, como los recientes hallazgos Huari en la zona del Castillo de Huarmey.

La iconografía es un componente más que suma valor agregado a una producción artesanal original, valiosa e innovadora que apunta al desarrollo sostenible de sus creadores y productores.

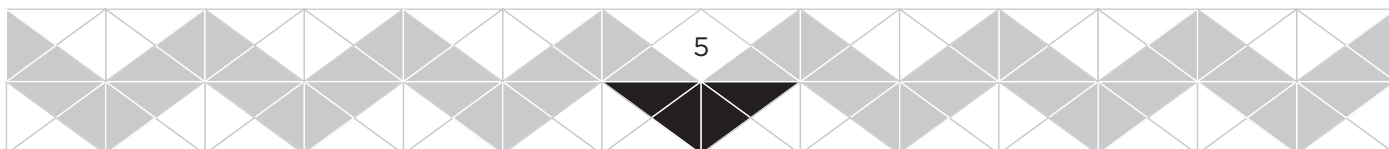

Como se usa este manual?

1. Las iconografías se ubican por tipo:

a. Iconos prehispánicos de la cultura Huari, cultura Lima, Ychma de Pachacamac, de Puruchuco en Ate.

b. Iconos de arquitectura Ayacuchana.

2. Se elige el mas adecuado según la técnica a emplear por sus características de línea o forma, y se extrae una parte aumentando el tamaño para trabajarla mejor.

3. Se encierra el fragmento en un cuadrado, como figura básica, para usarlo como patrón de composición.

4. Se buscan las combinaciones posibles para explorar sus alternativas, esto nos llevará a elegir las mas adecuadas según el tipo de producto en el que se empleará.

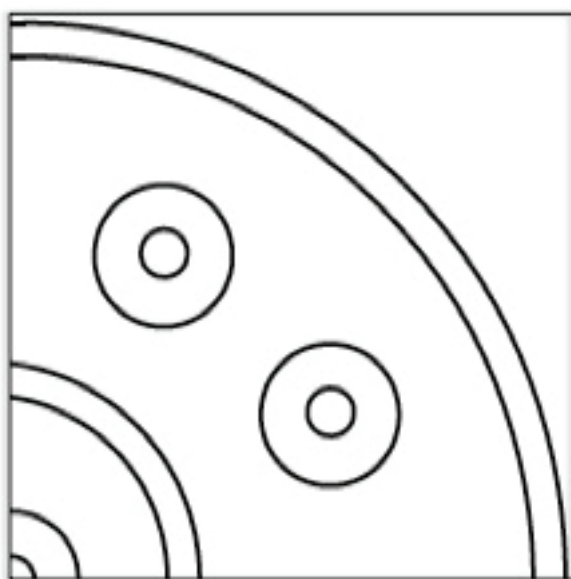
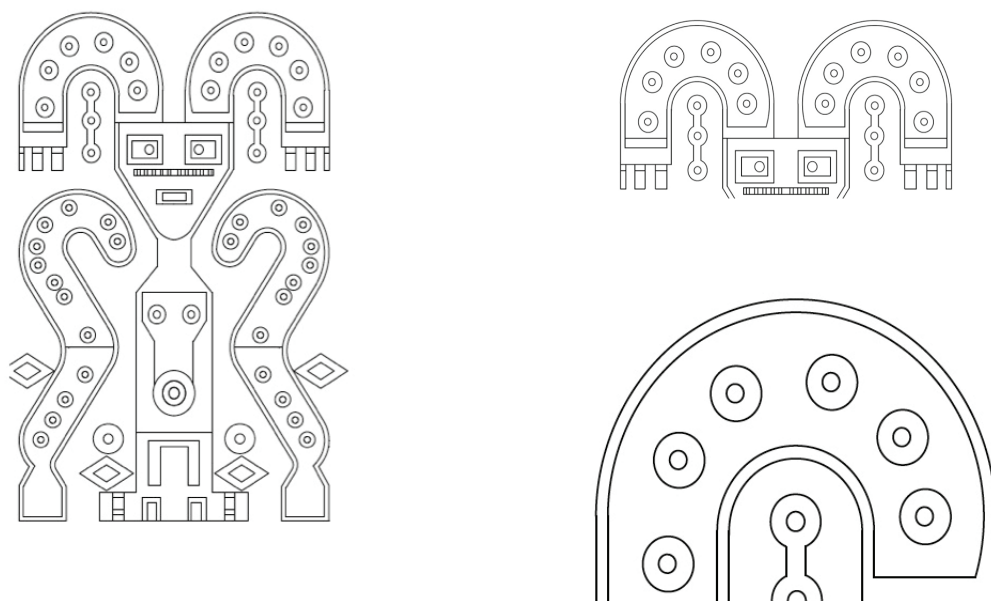

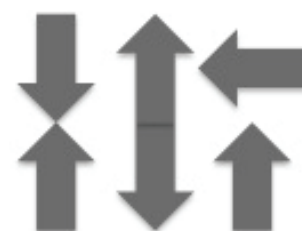
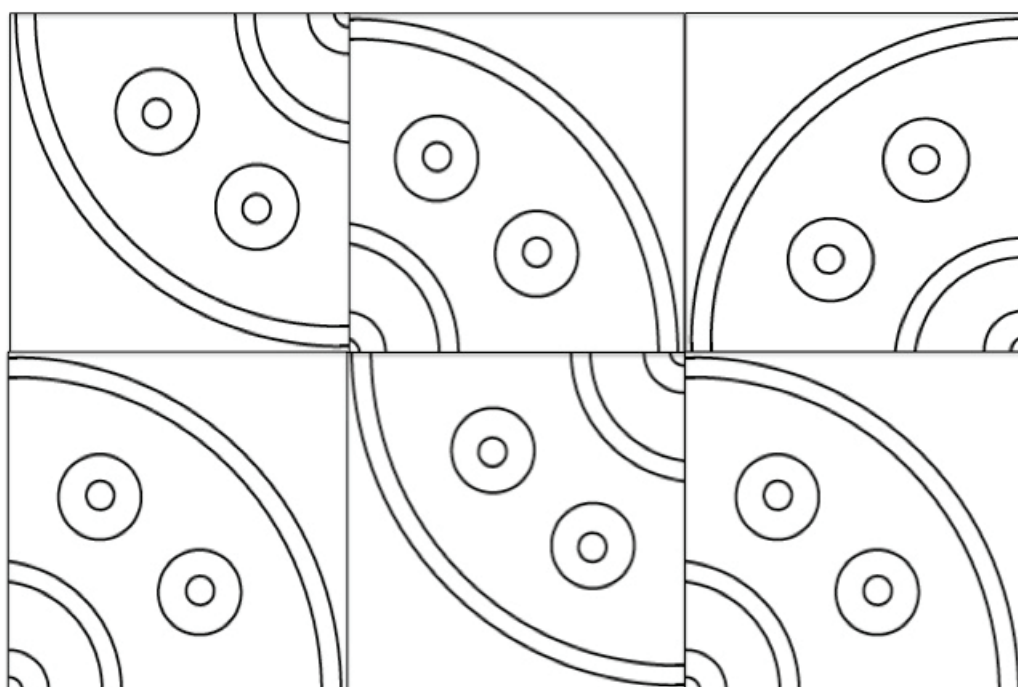
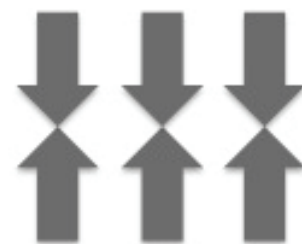
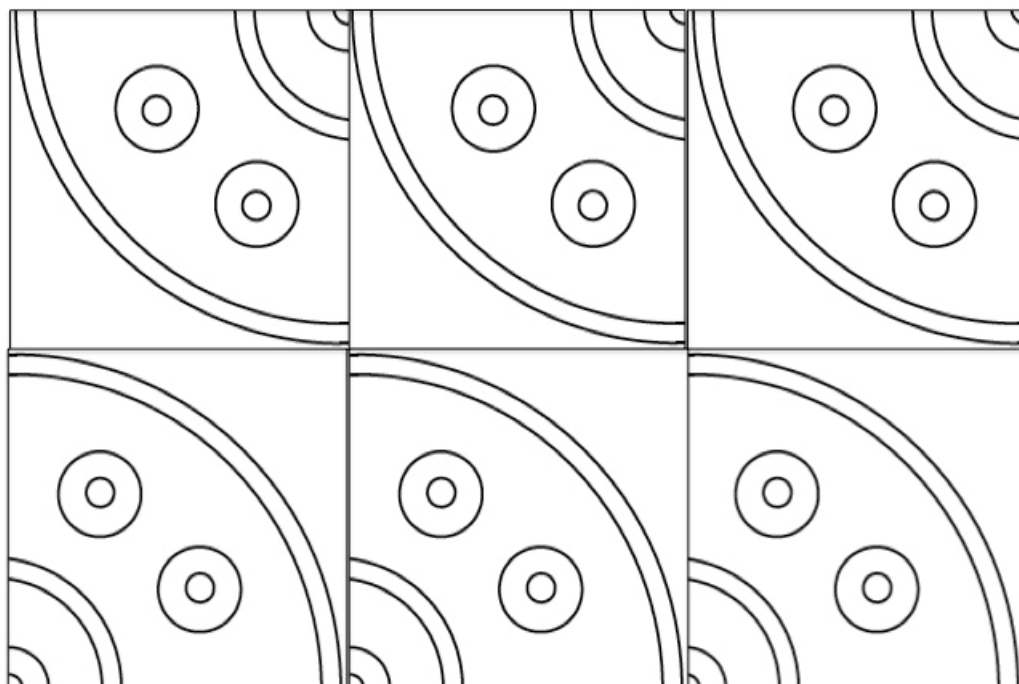
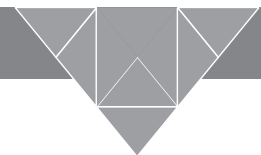

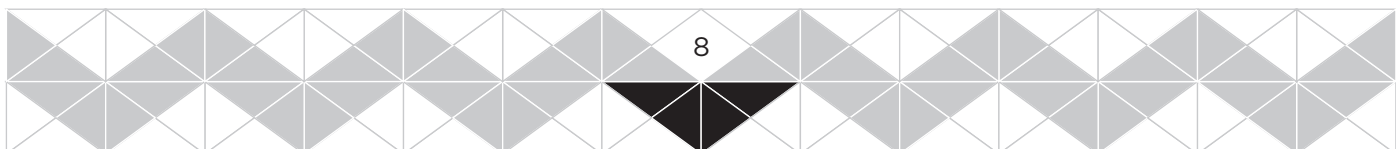
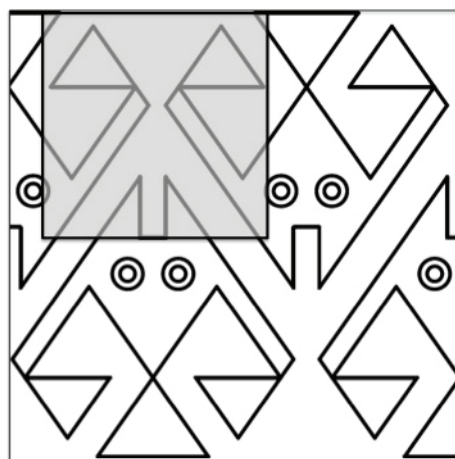
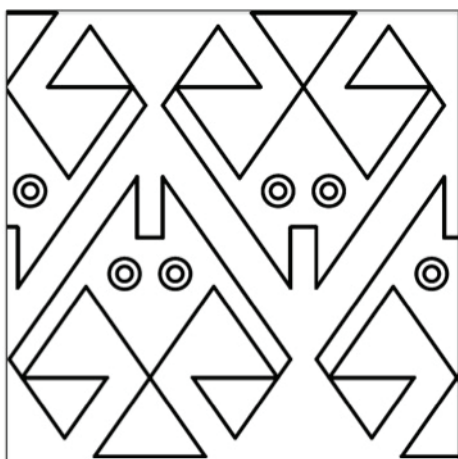
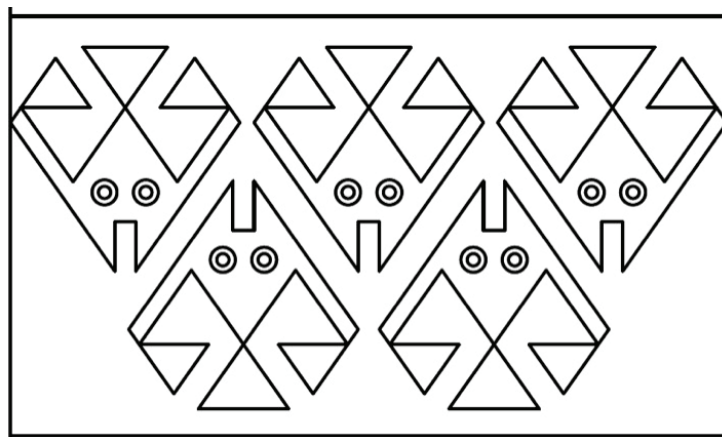
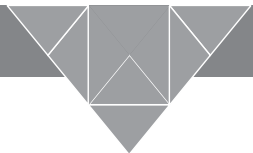

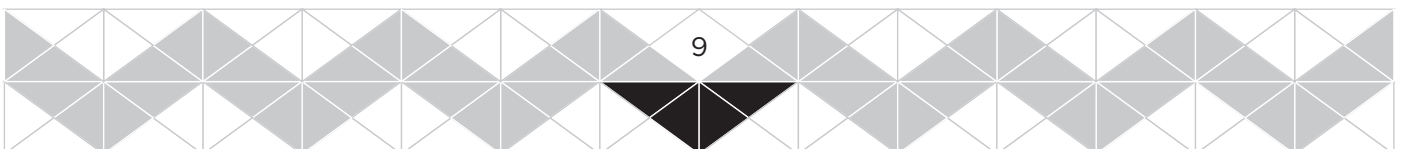
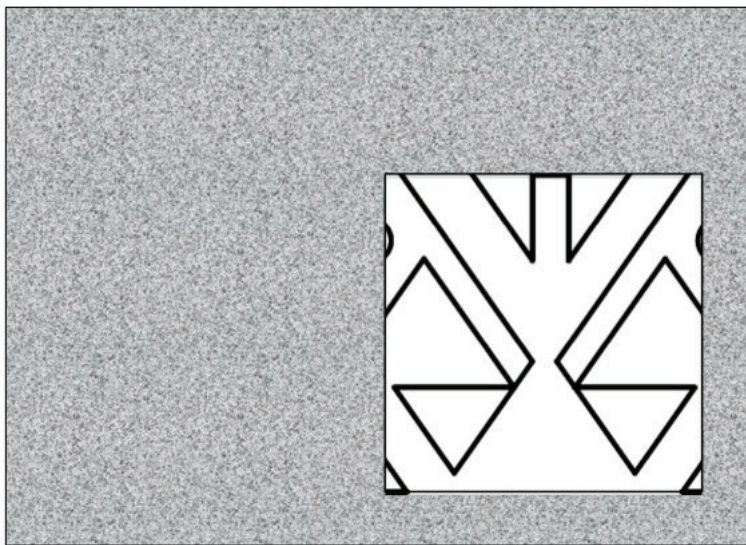
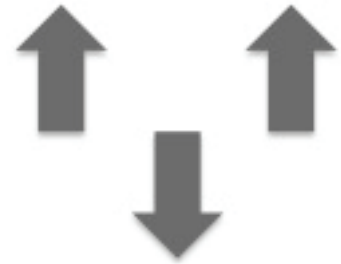
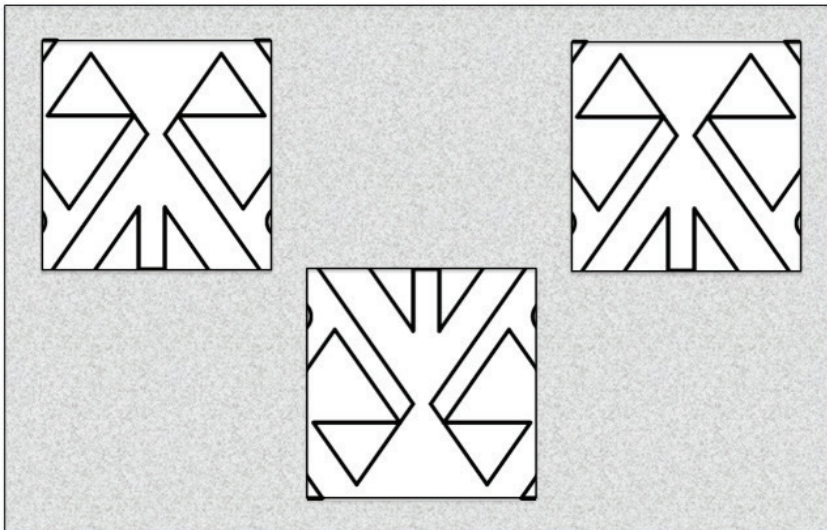
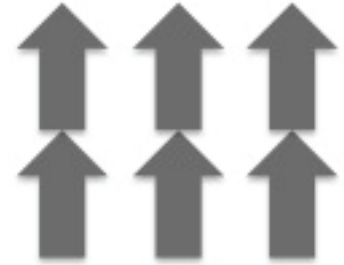
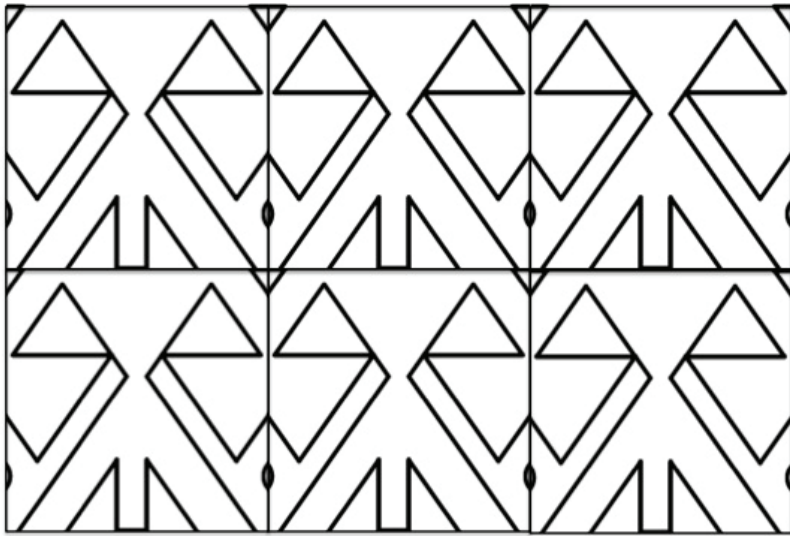

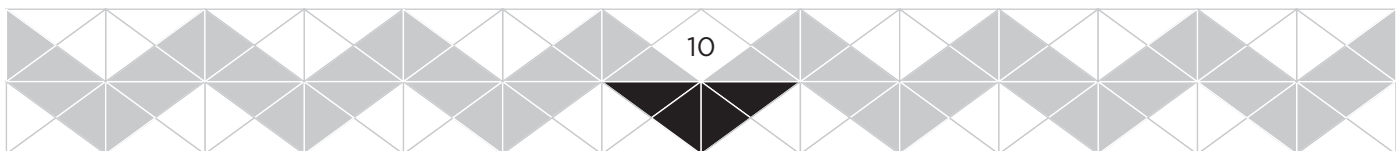
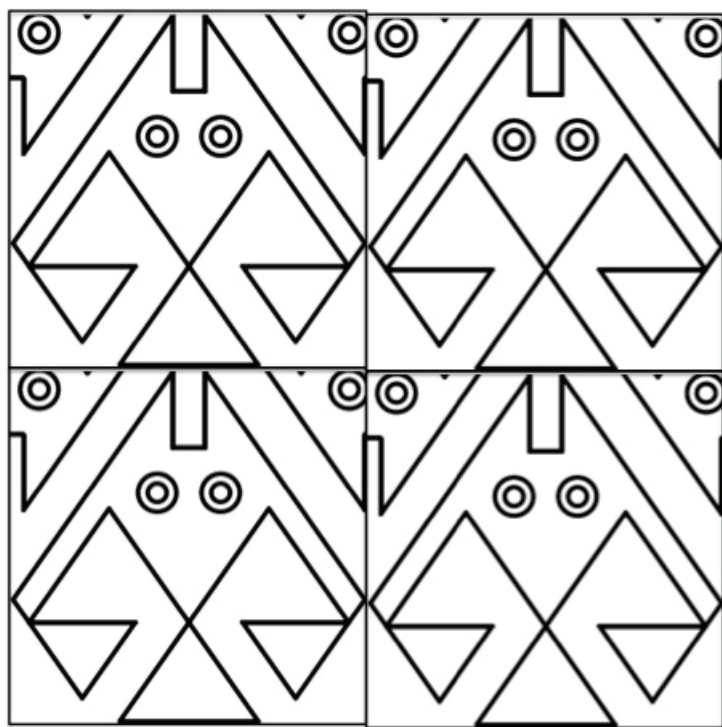
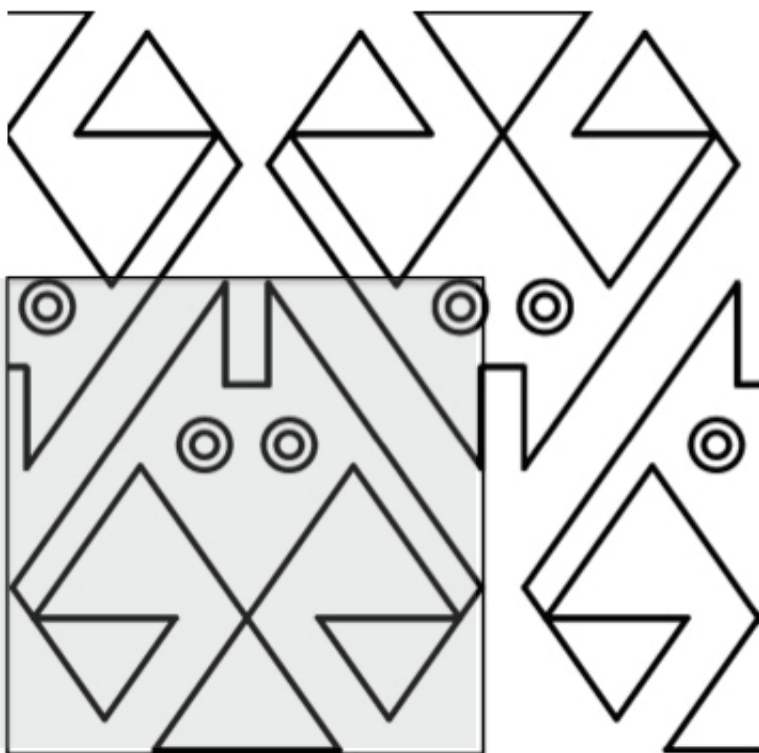
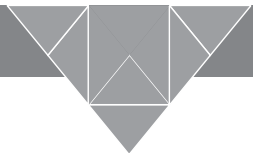

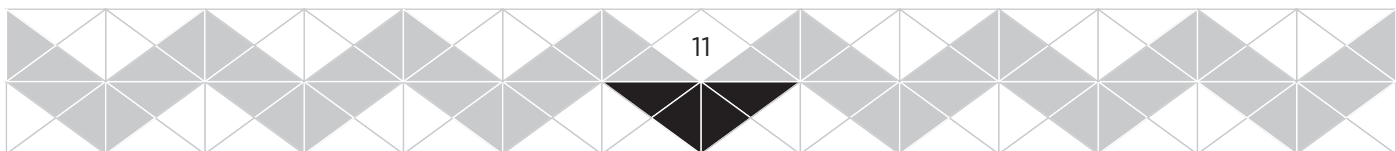
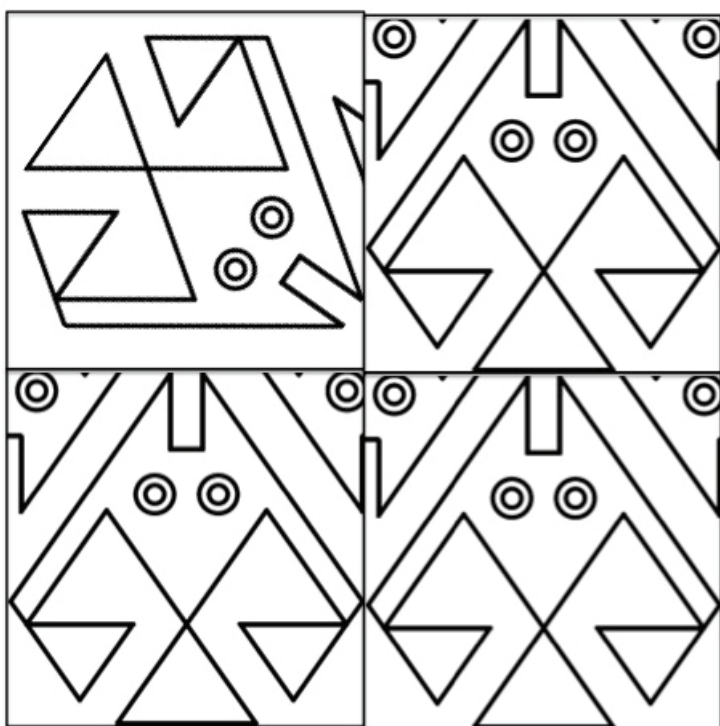
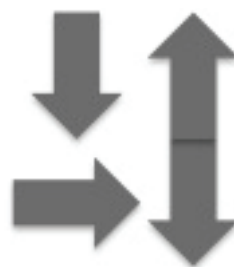
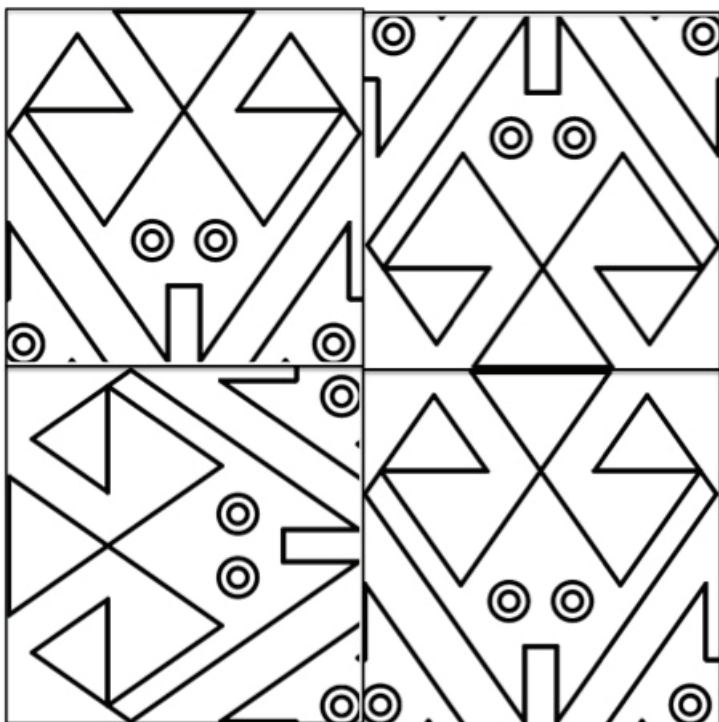
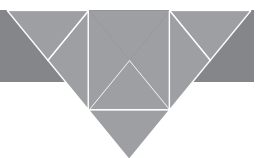

Cultura Prehispánica

HUARI

Cerámica *[Antropomorfo, Humanos]*

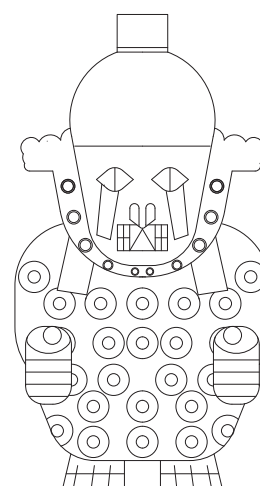
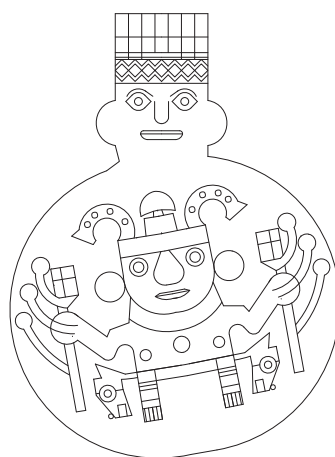
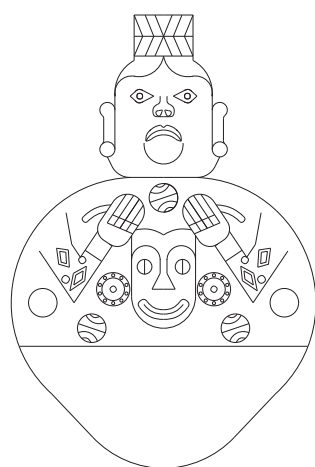
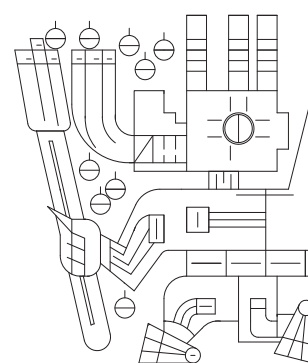
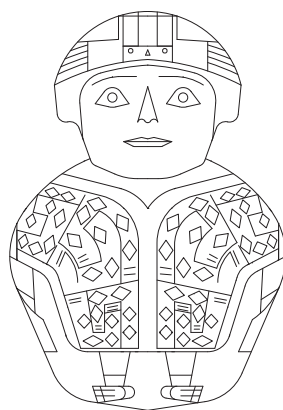
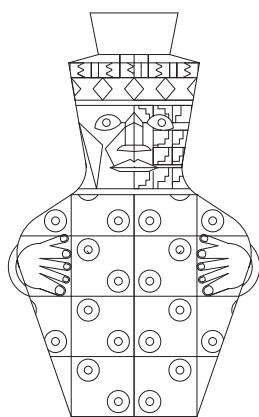
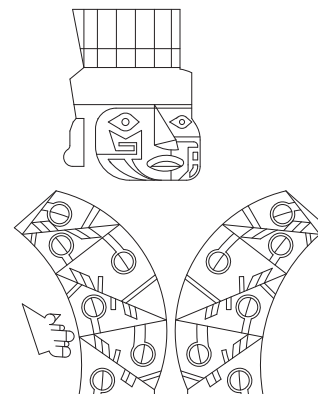
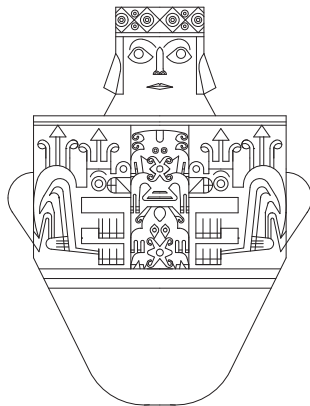
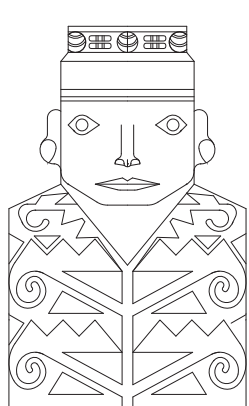

[Antropomorfo, Mitológicos]

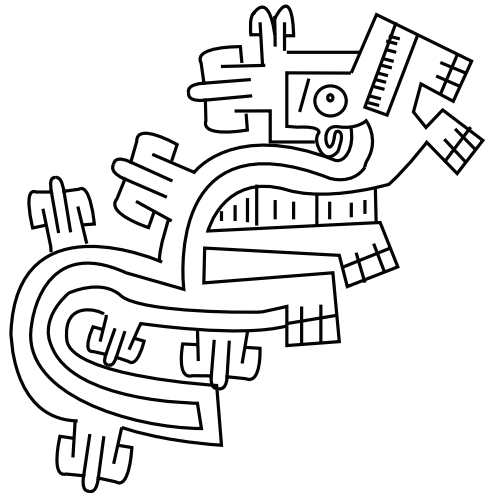
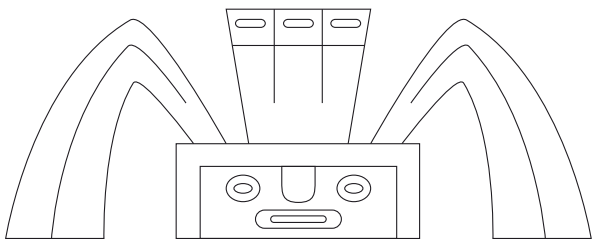
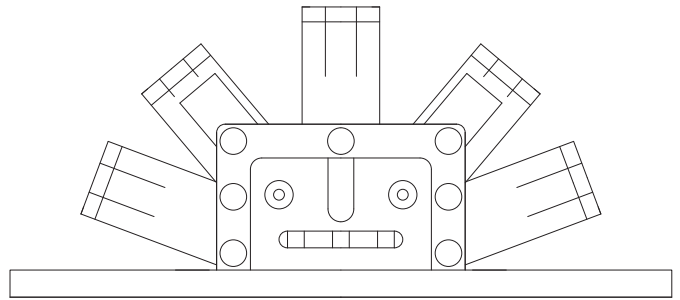
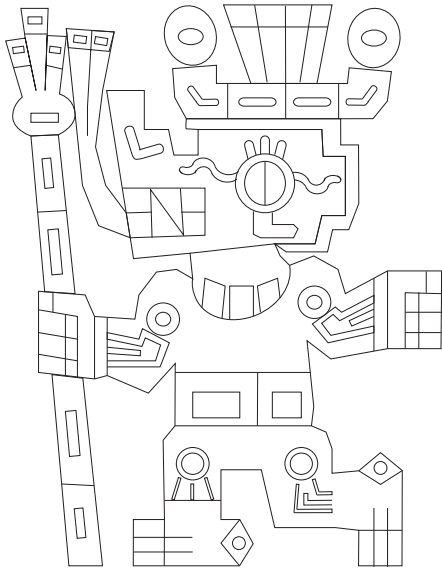
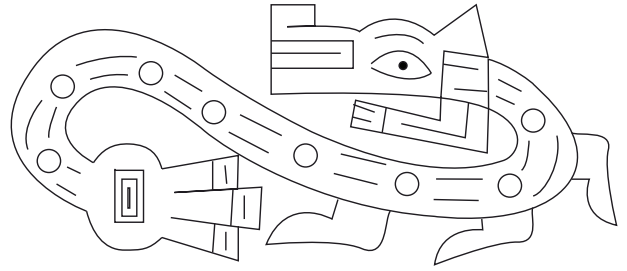
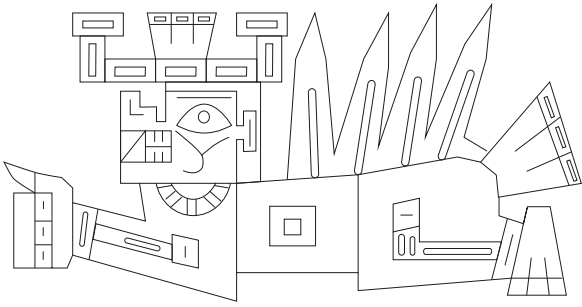

[Antropomorfo, Mitológicos]

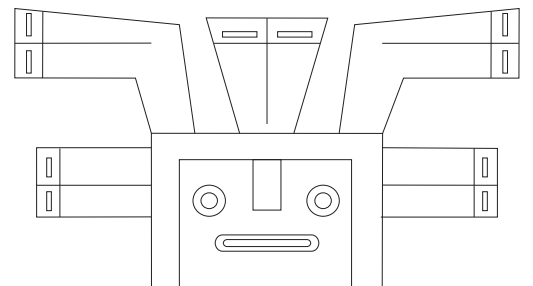
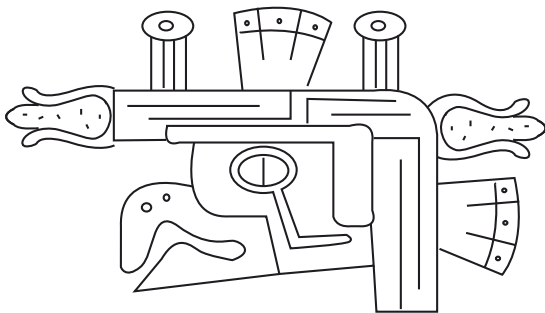
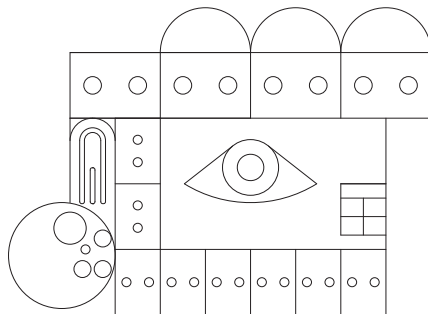
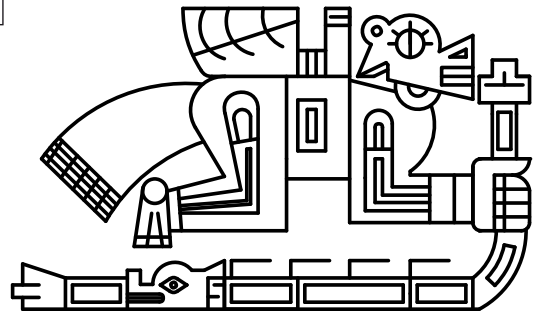
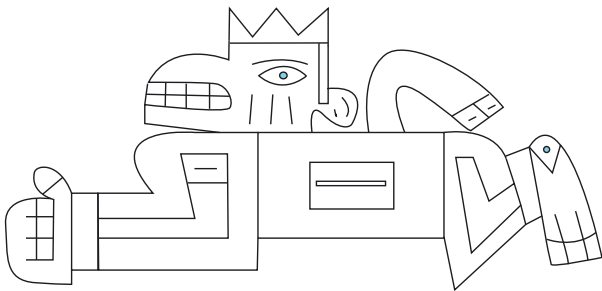
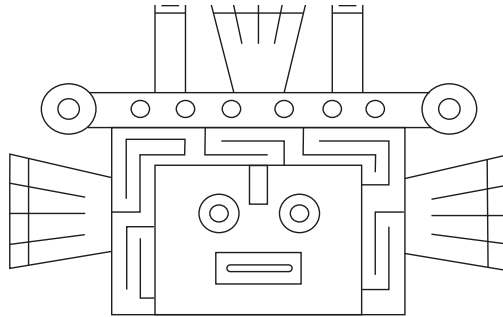
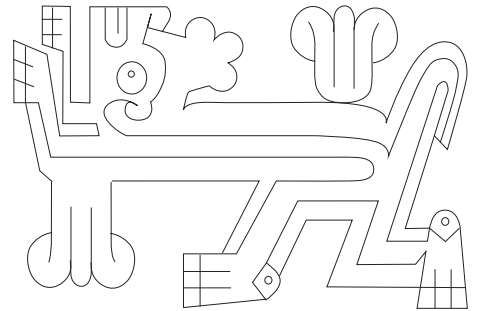
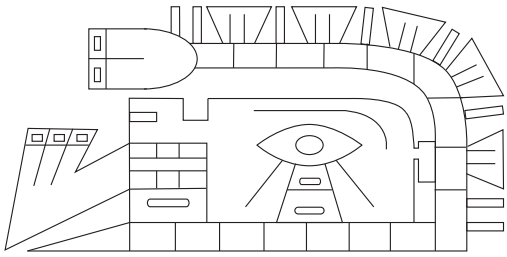

[Zoomorfo, Felinos]

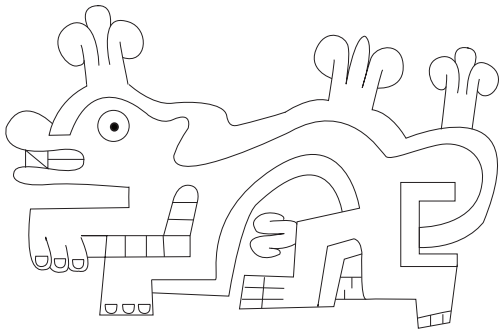
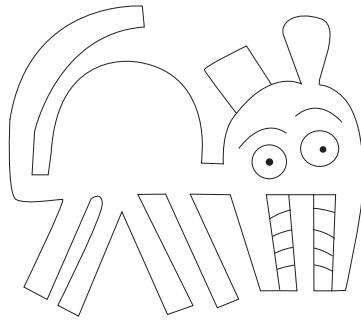
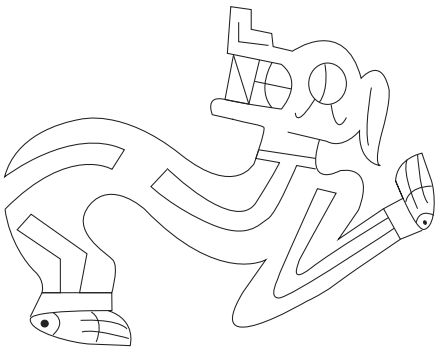

[Zoomorfo, Aves]

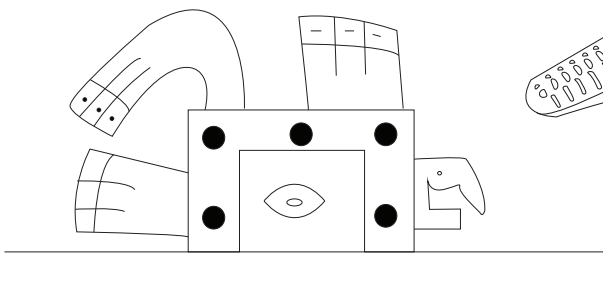
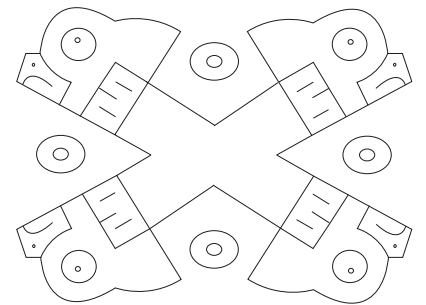
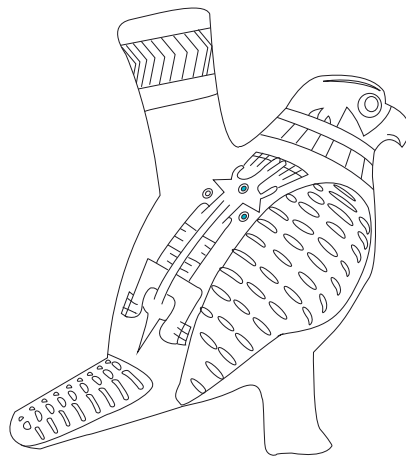
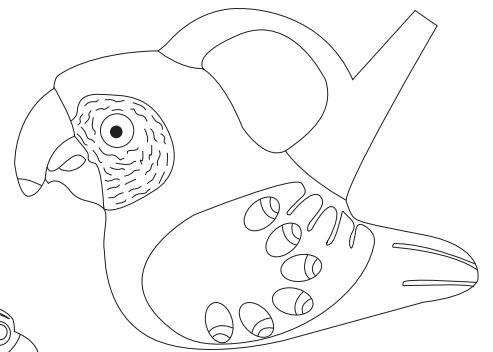
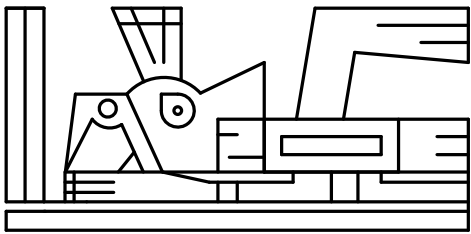

[Zoomorfo, Otros]

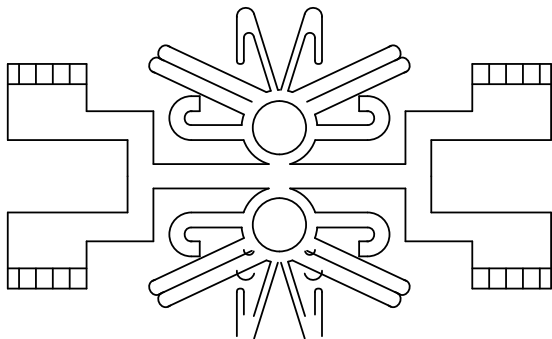
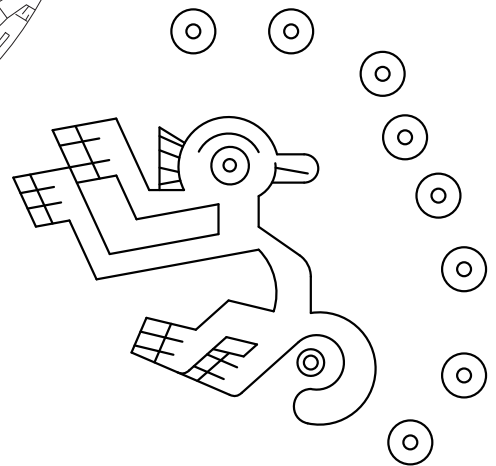
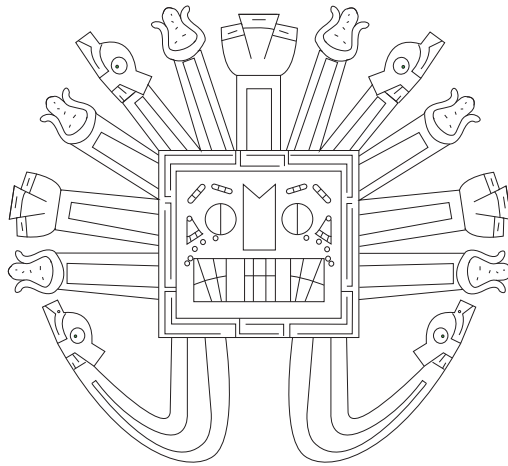
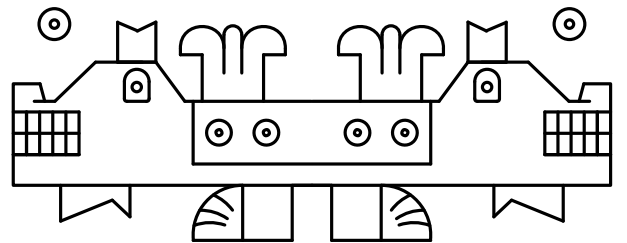
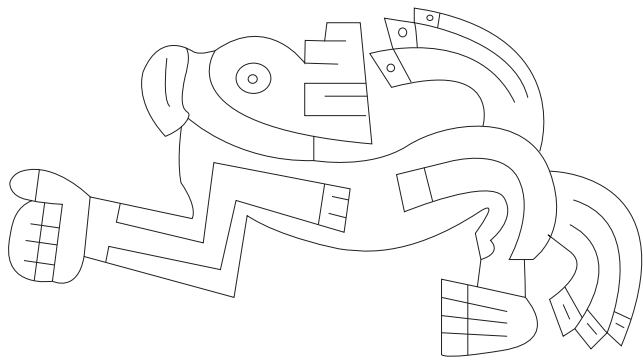
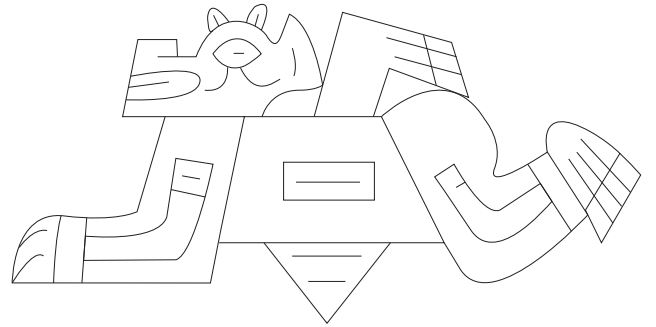
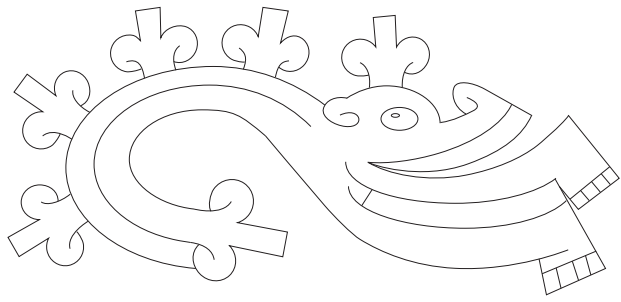

[Zoomorfo, Serpientes]

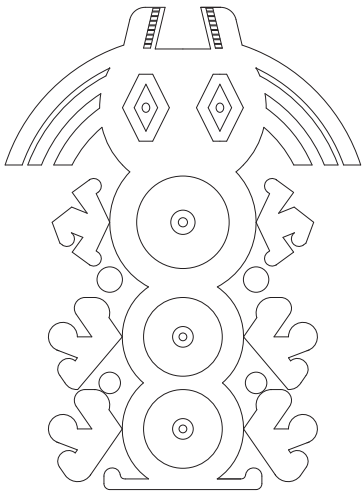

[Fitomorfo]

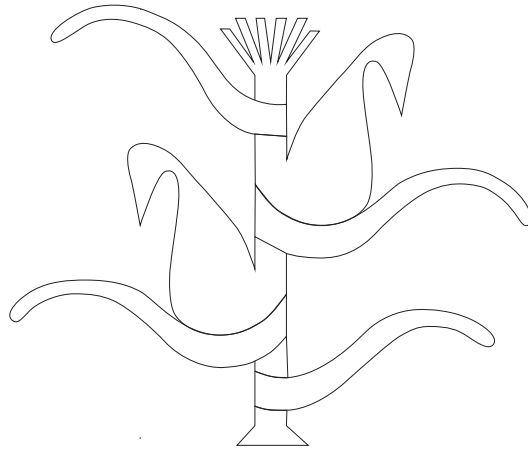

[Geométrico]

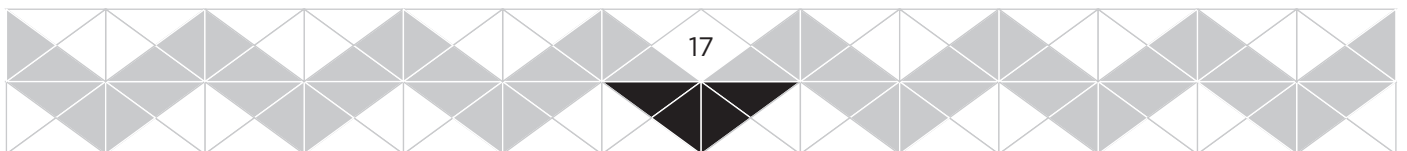
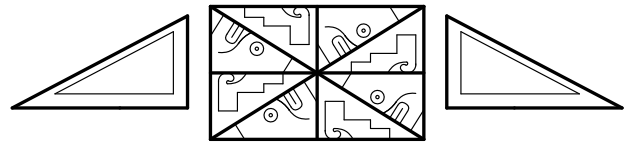
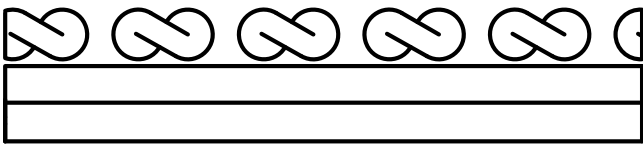
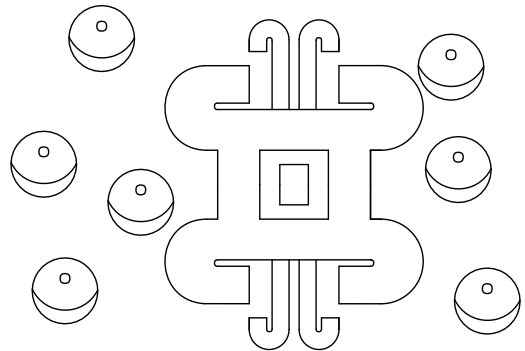
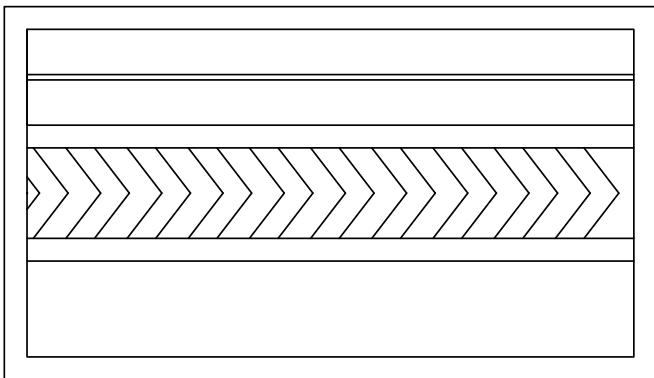

Textil [Antropomorfo, Humanos]

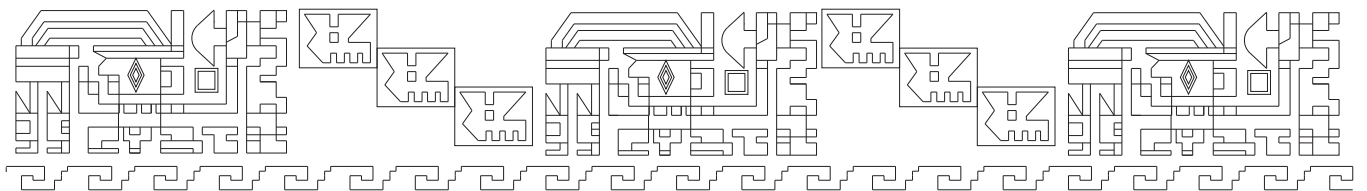
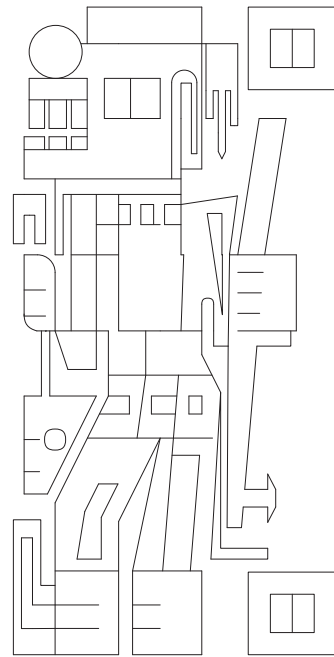
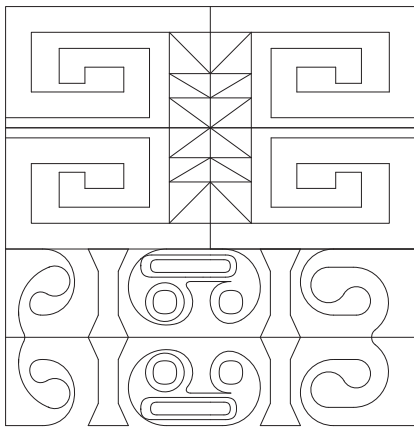
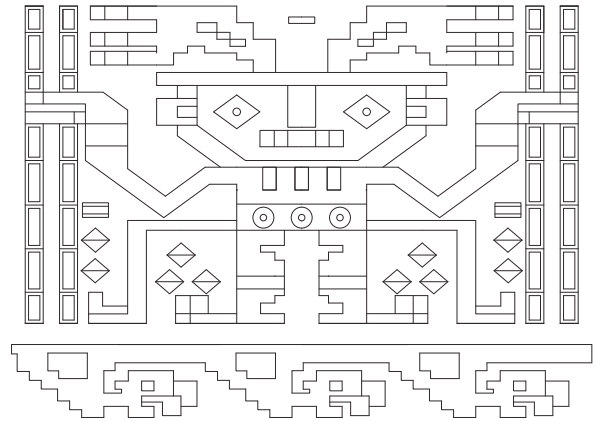
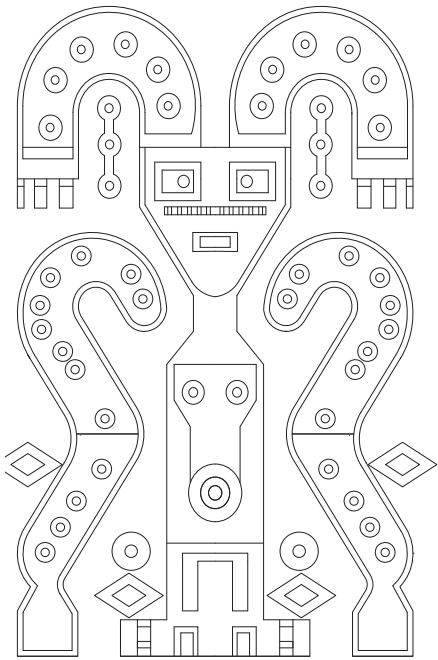

[Antropomorfo, Mitológicos]

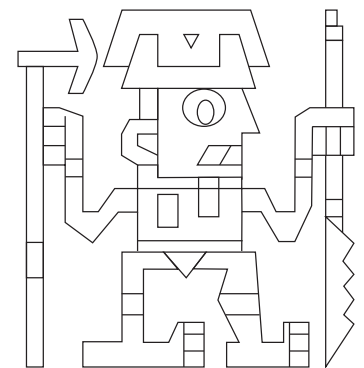
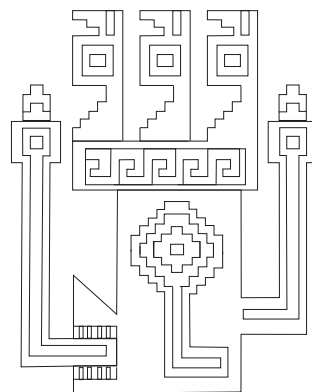
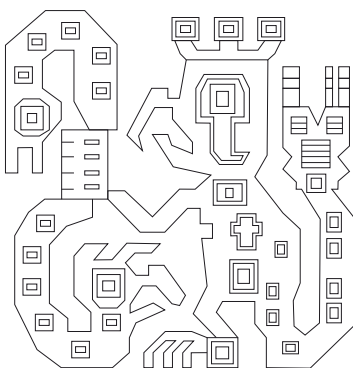
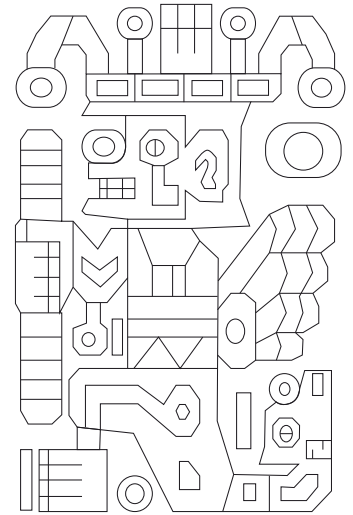
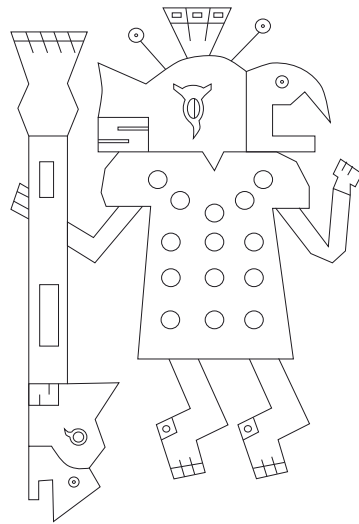
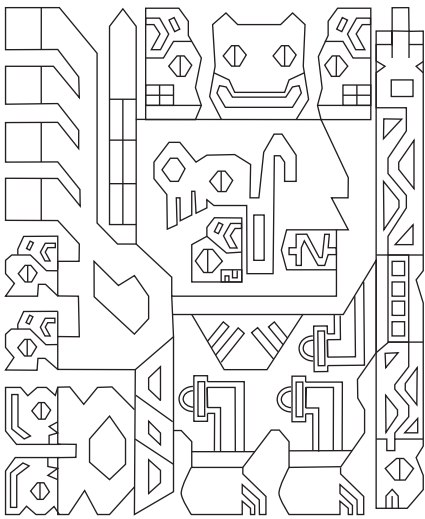
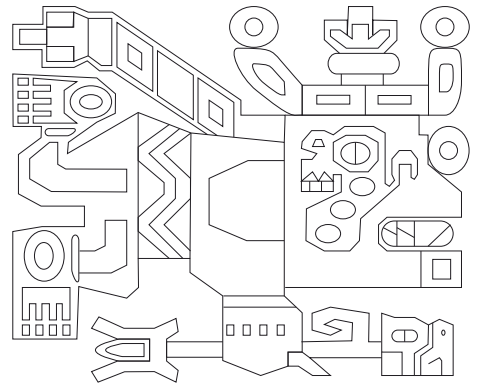
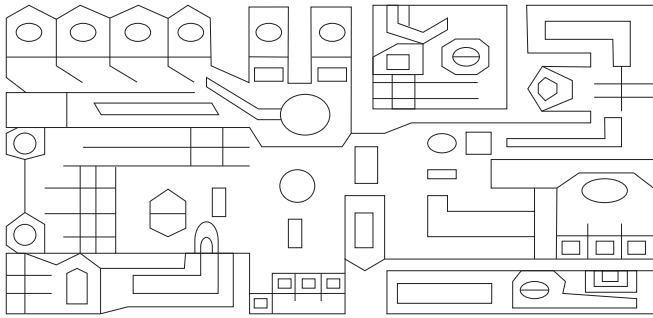

[Antropomorfo, Mitológicos]

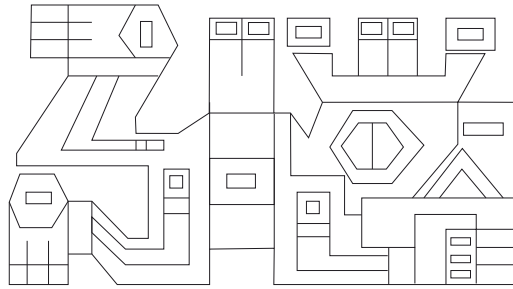
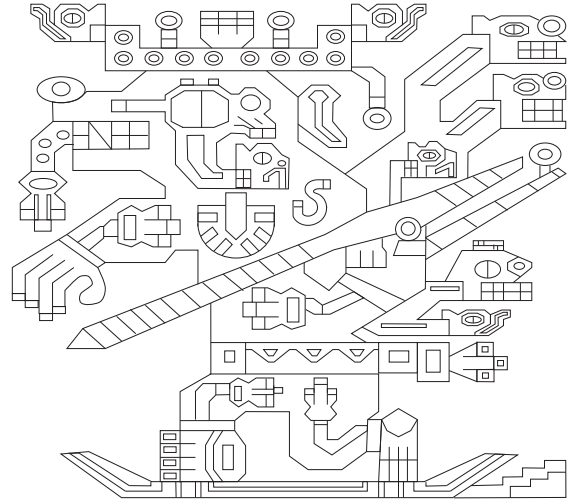
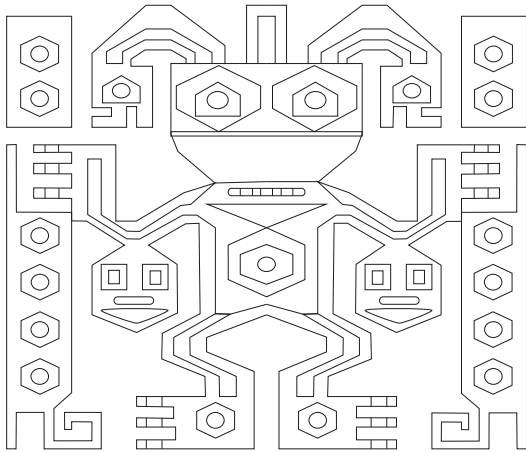

[Zoomorfo, Aves]

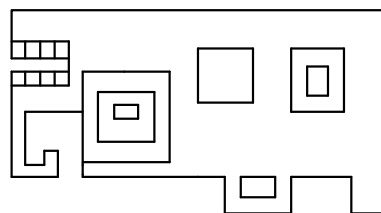
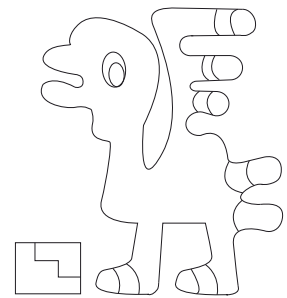
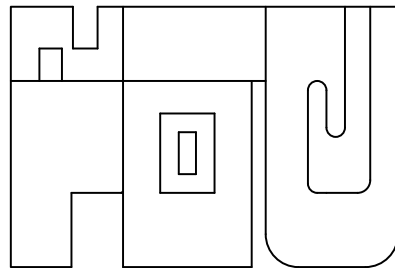
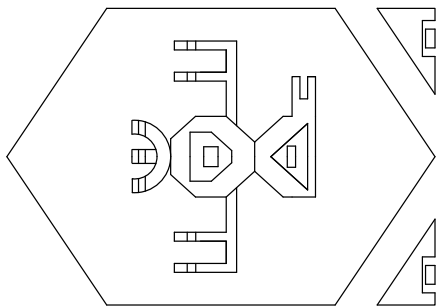

[Zoomorfo, Serpientes]

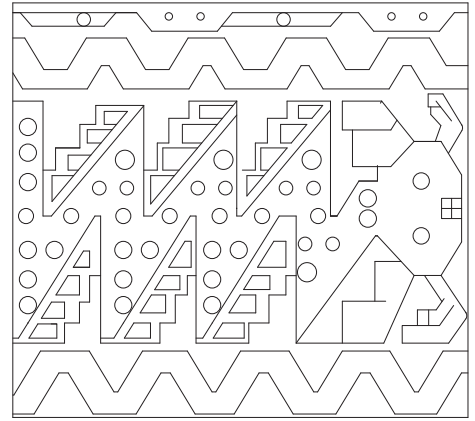
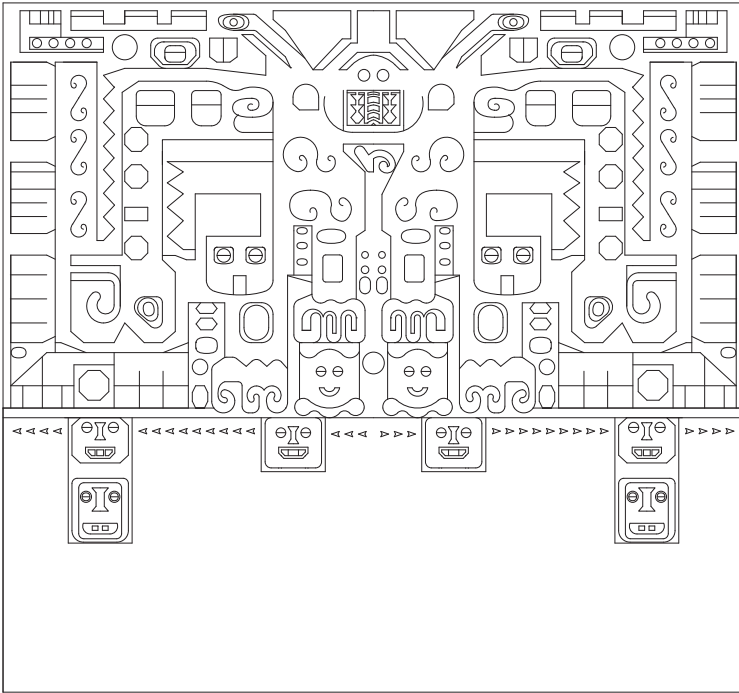

[Zoomorfo, Otros]

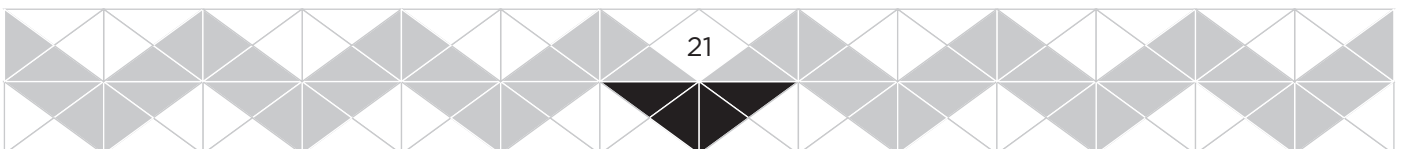
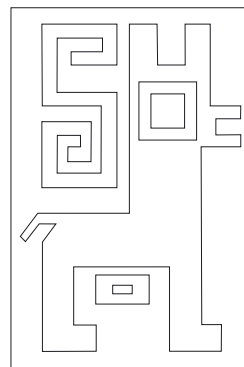
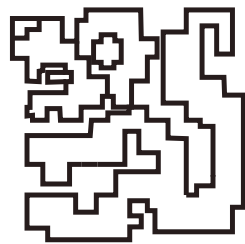
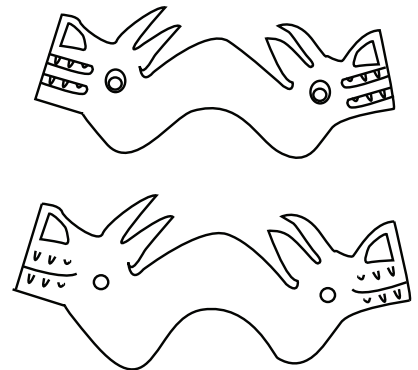
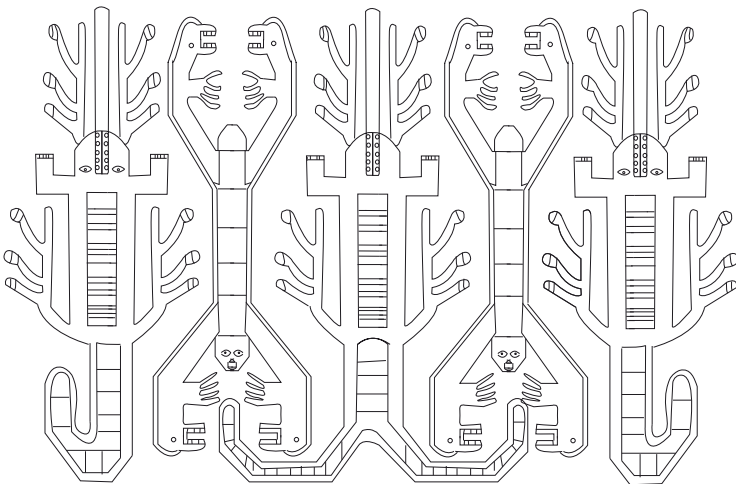

[Fitomorfo]

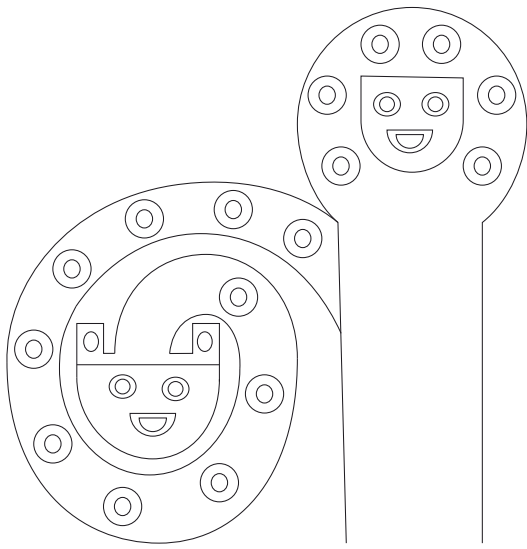

[Geométrico, Espirales]

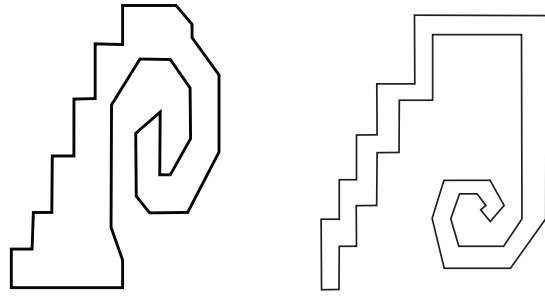

[Geométrico, Escalonados]

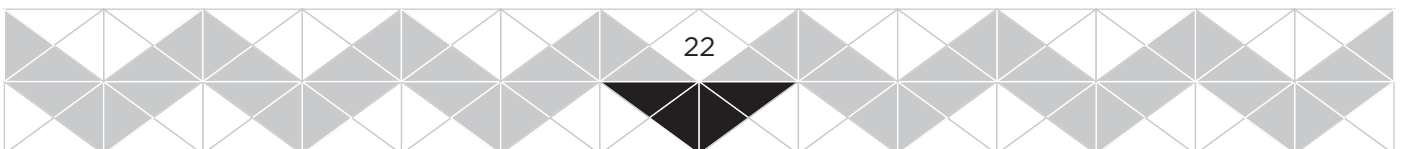
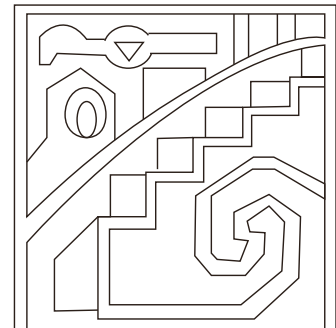
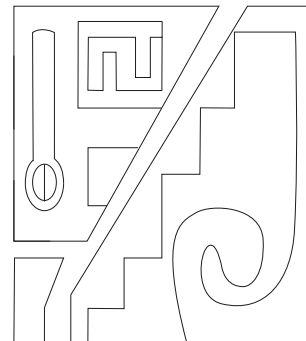
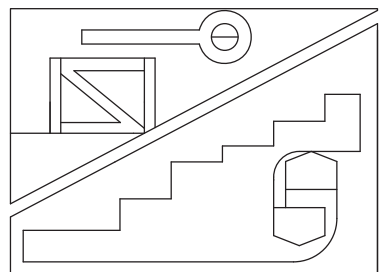
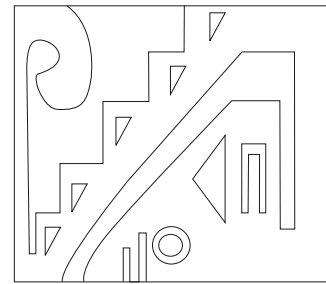
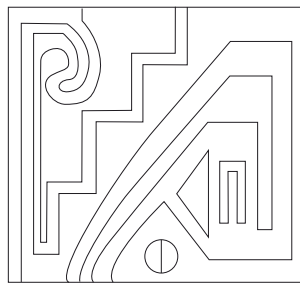
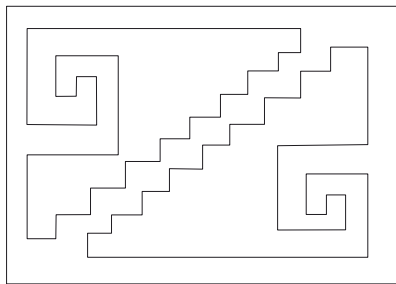

Geométrico, Otros

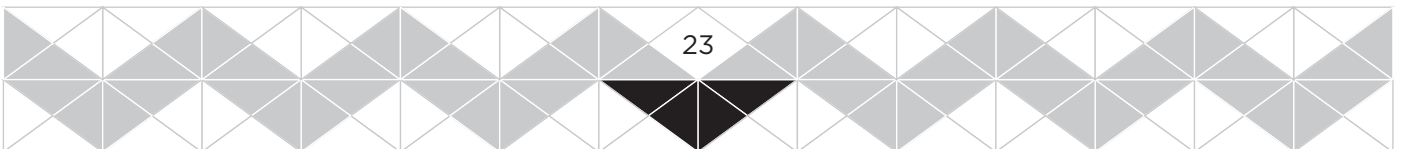
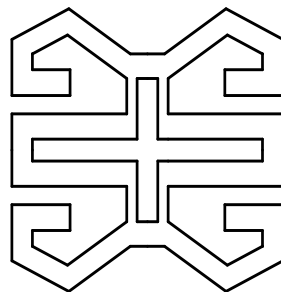
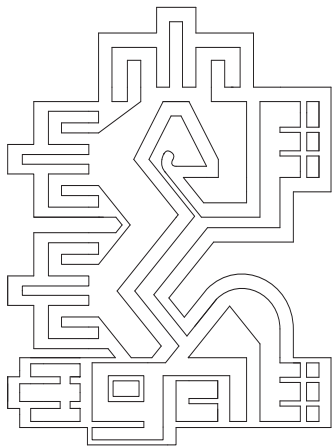
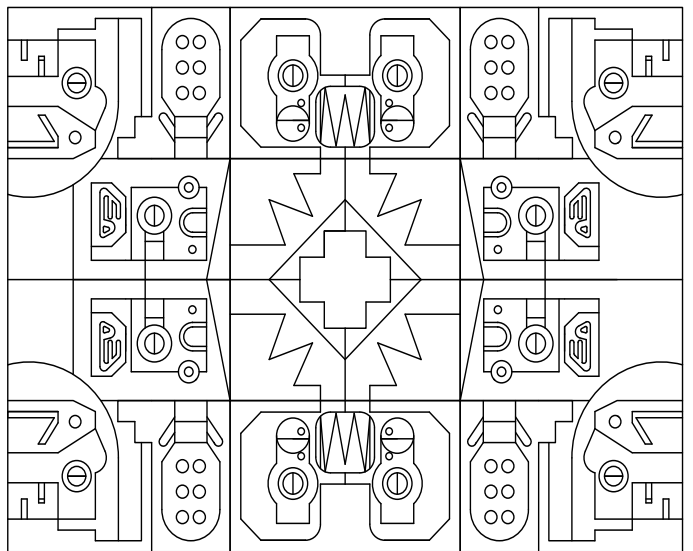
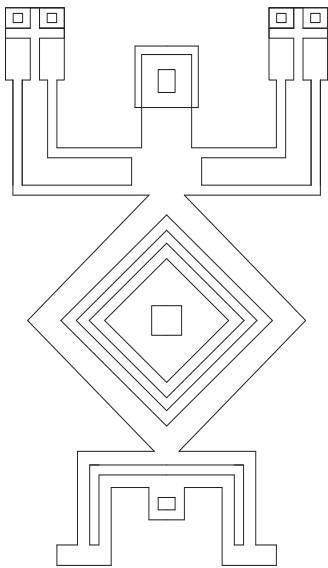
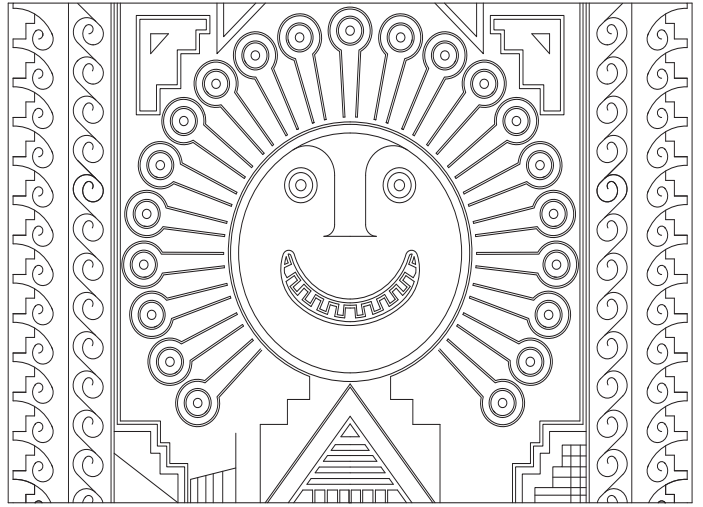
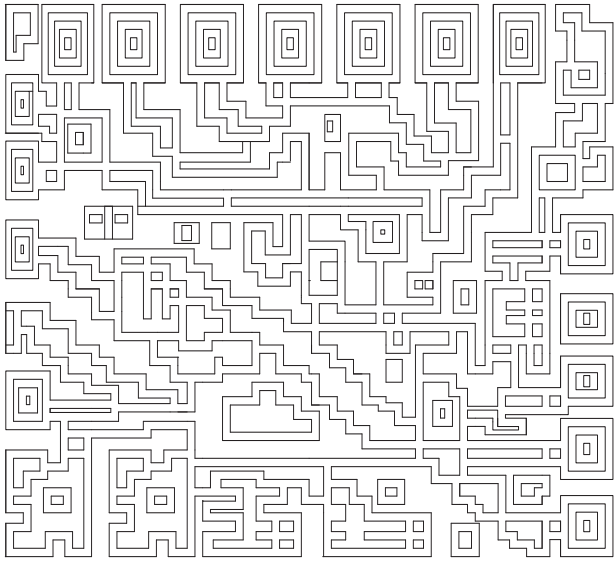

Cultura Prehispánica

PACHACAMAC

Textil

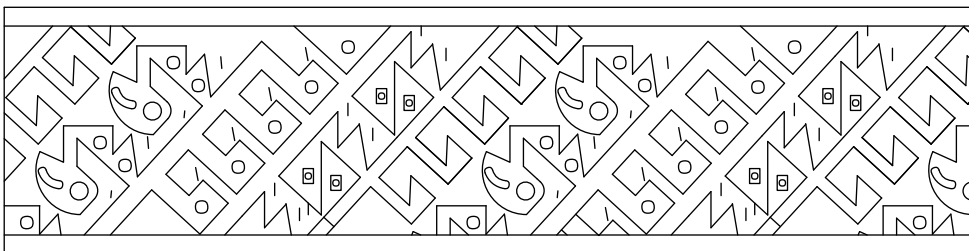
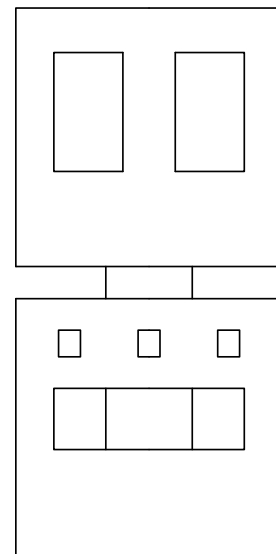
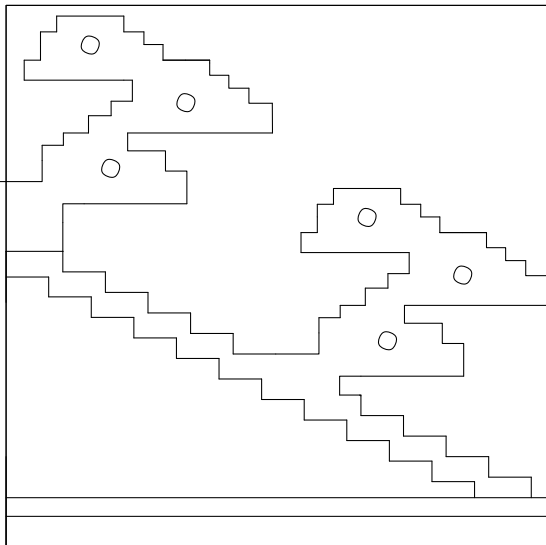
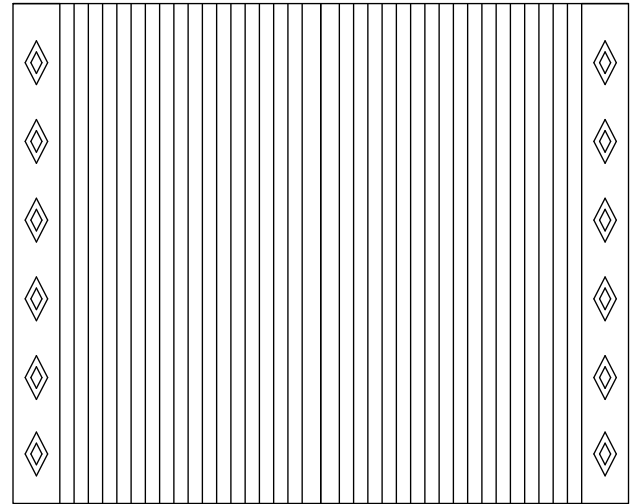
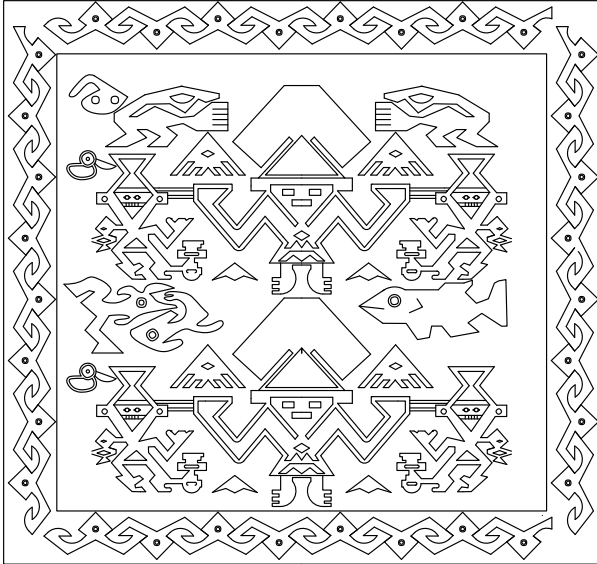

[Ídolo Pachacamac]

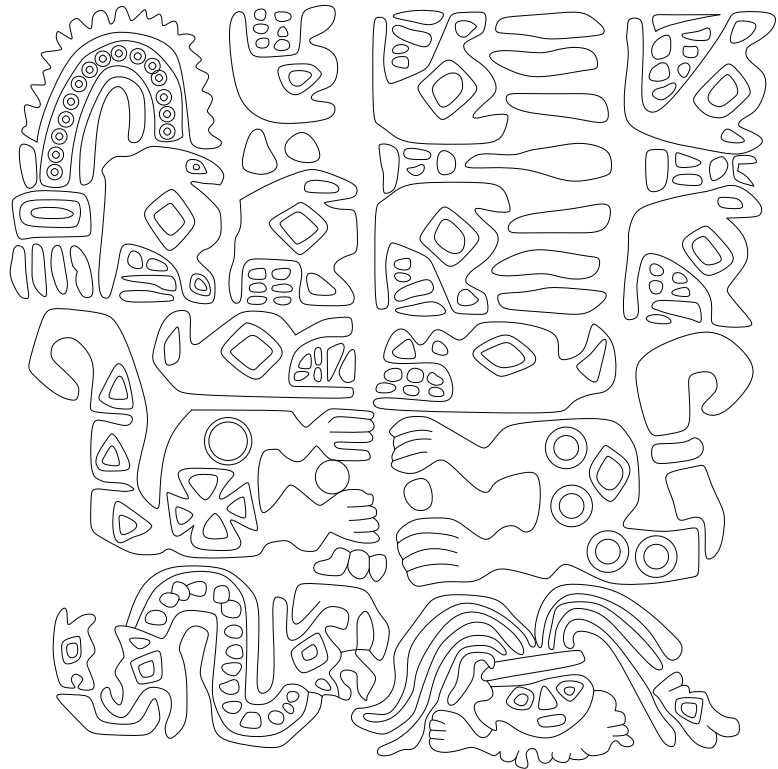
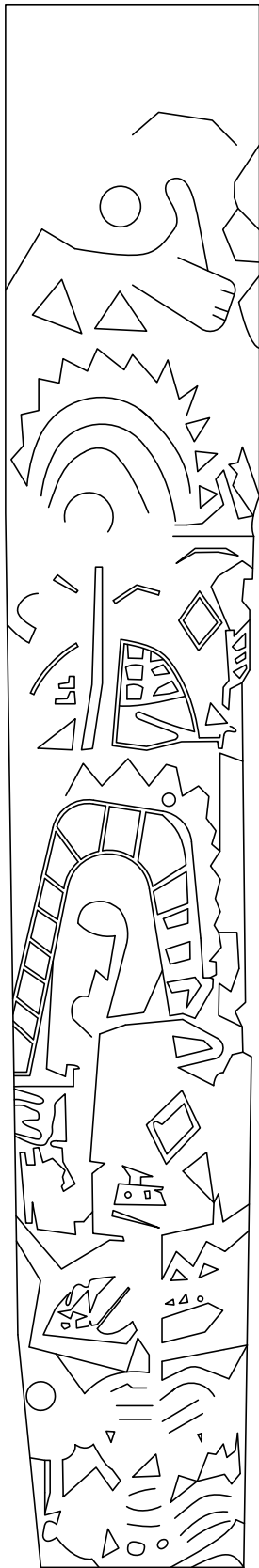

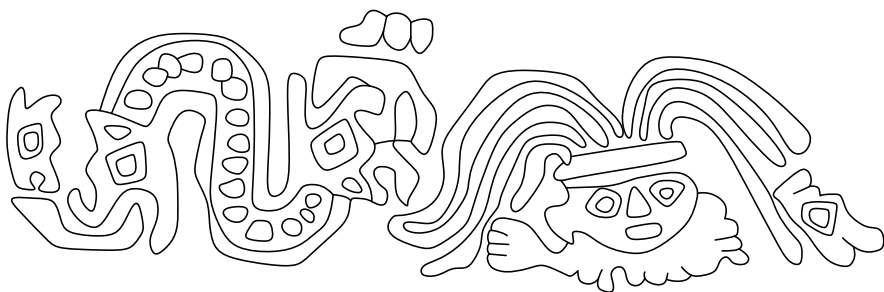
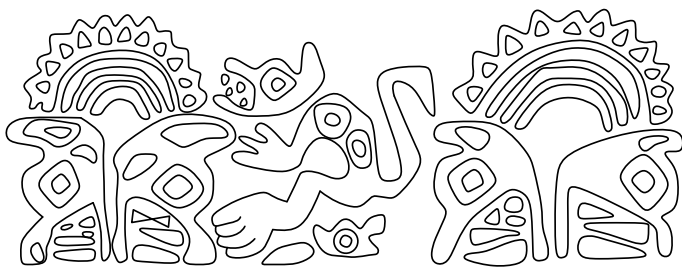
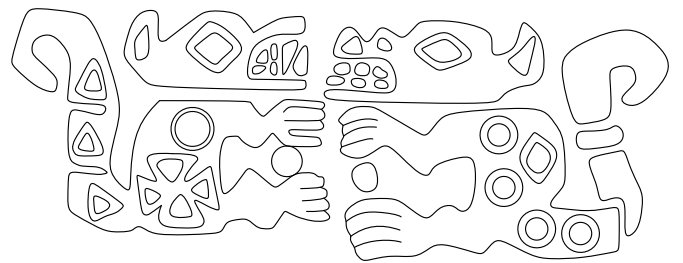
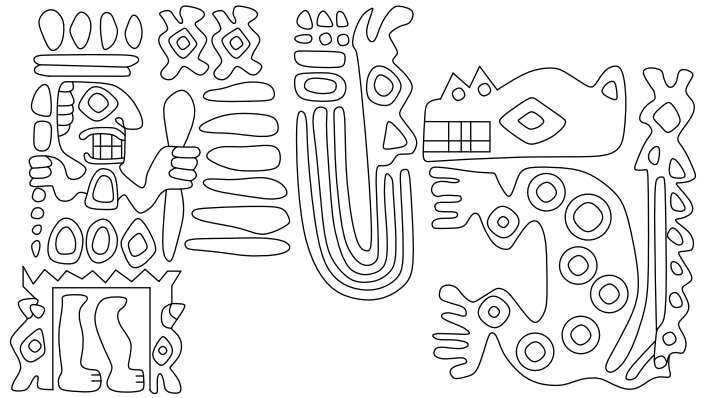
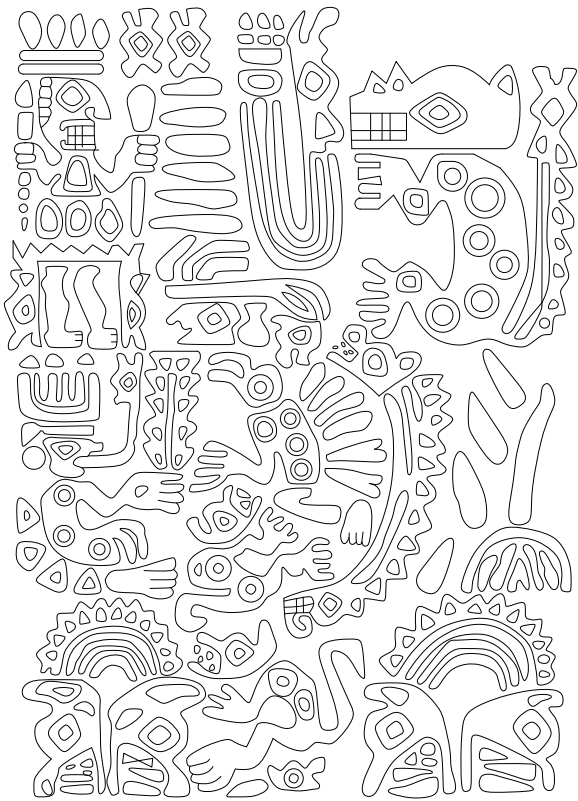

Cerámica

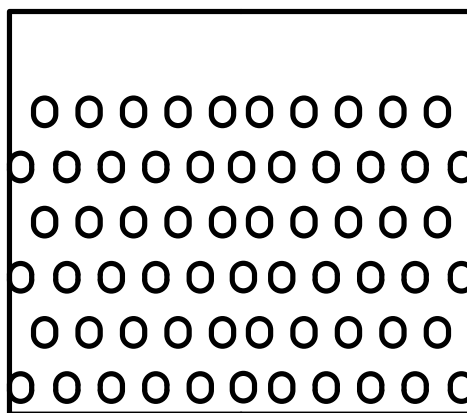
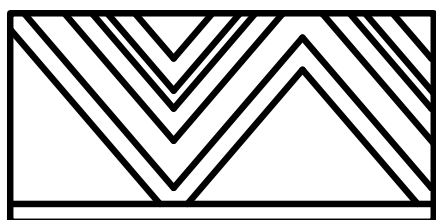
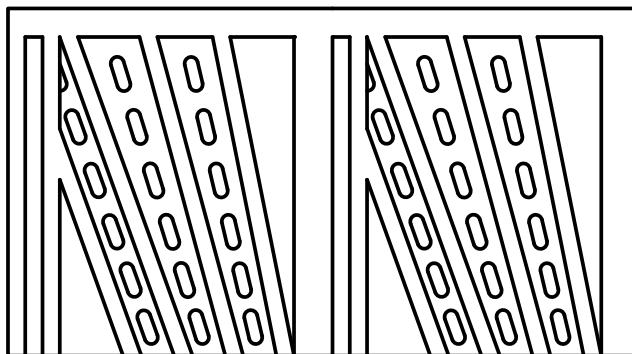
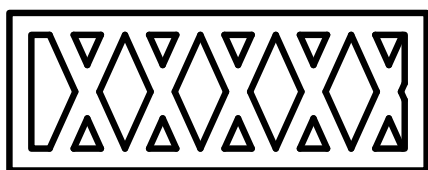
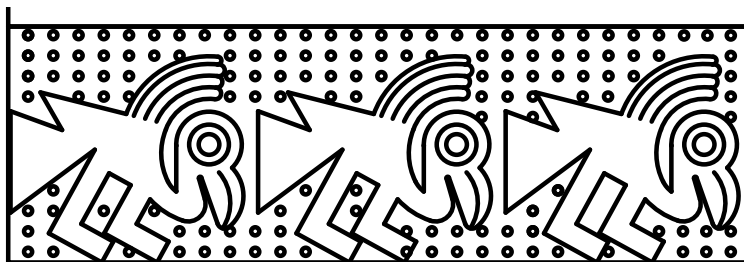
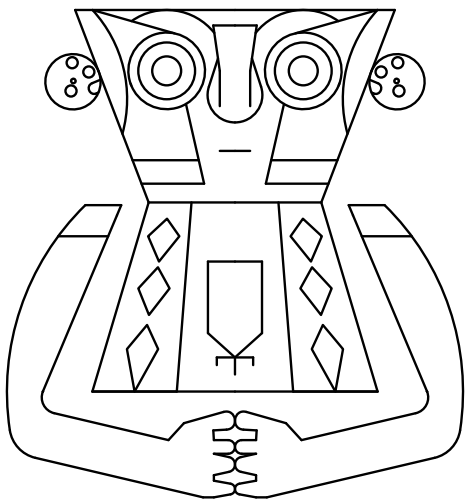

Cultura Prehispánica

PURUCHUCO

Cerámica

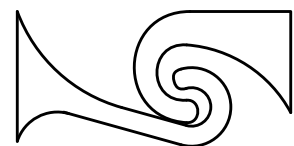
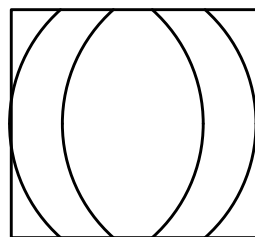
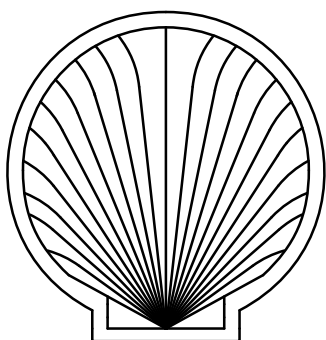
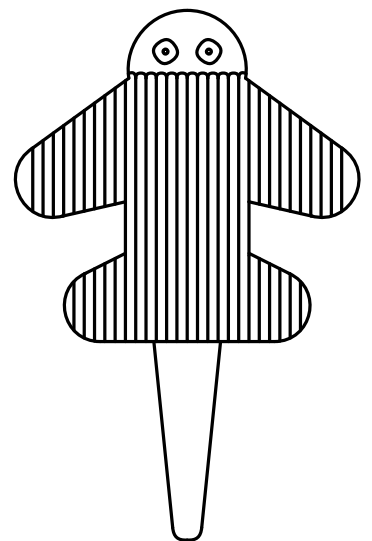
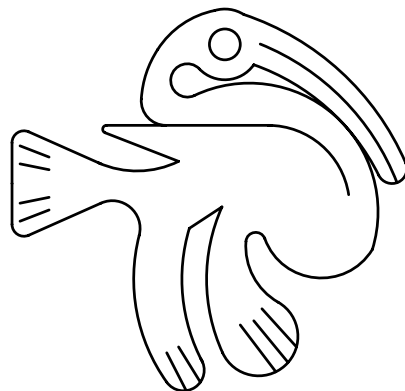
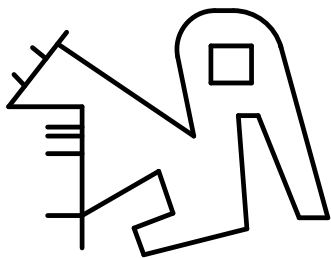
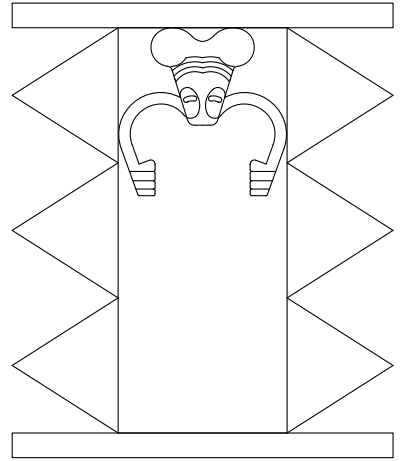
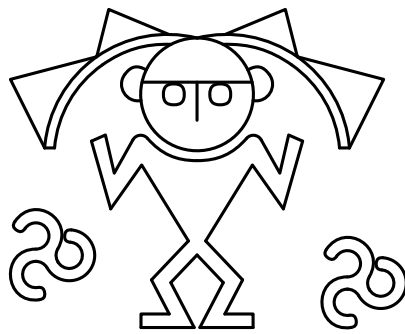

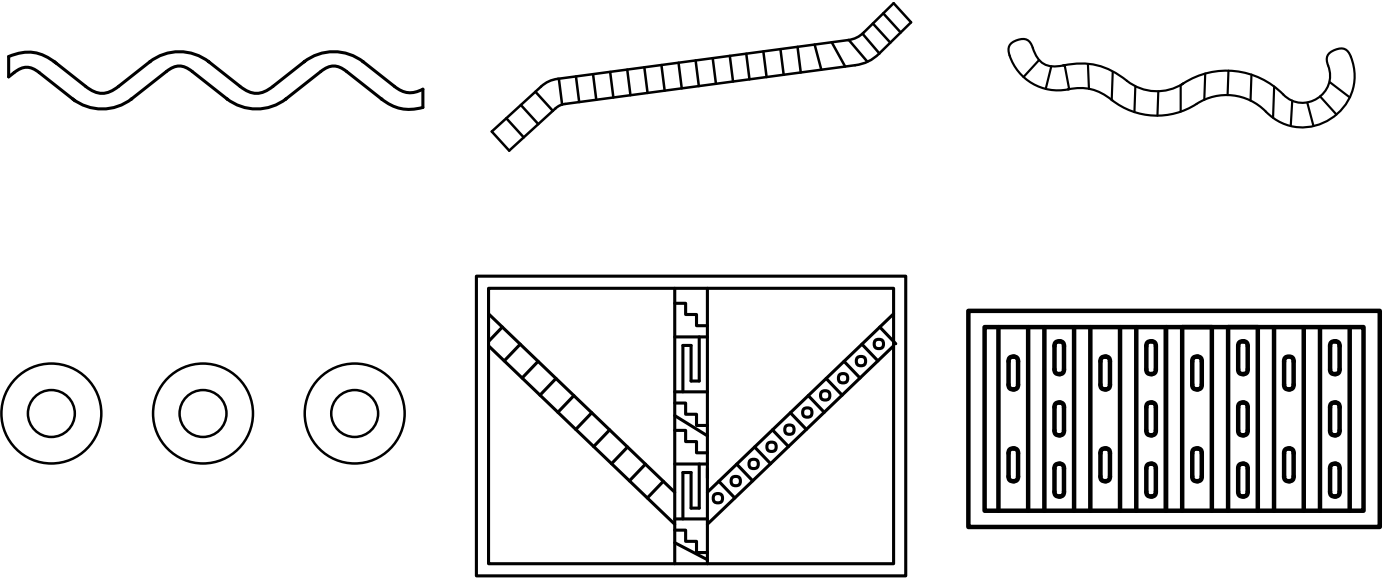

Textil

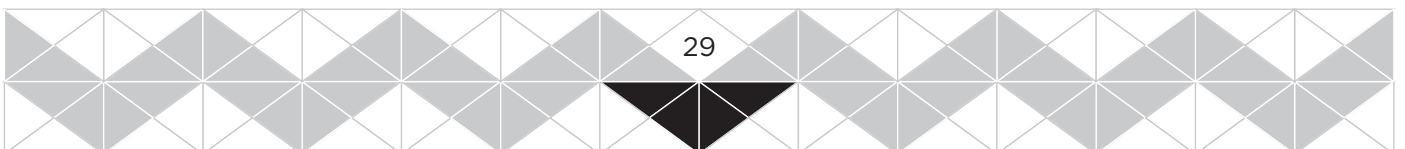
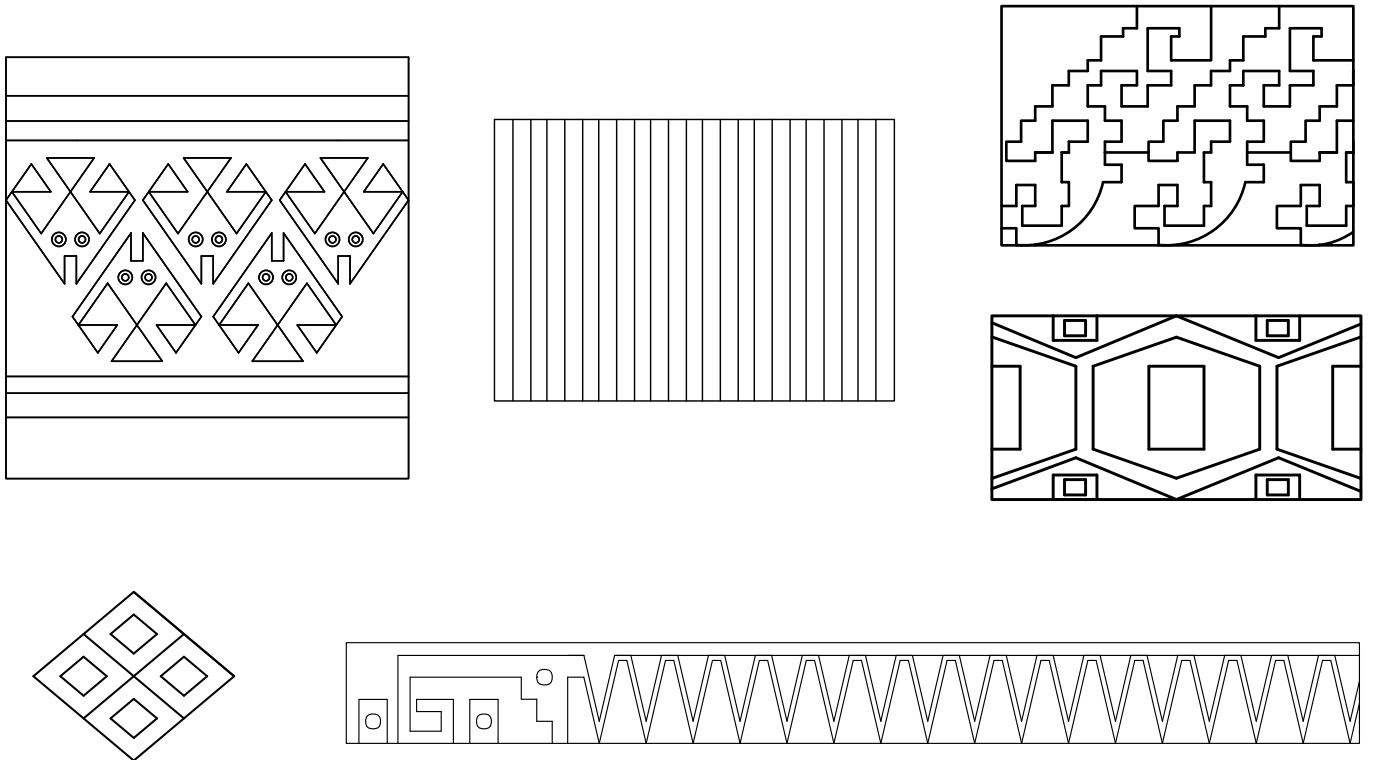

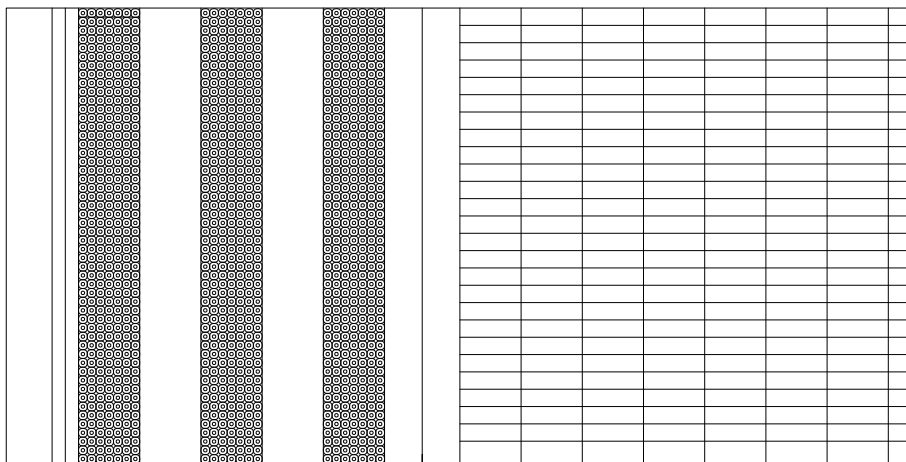
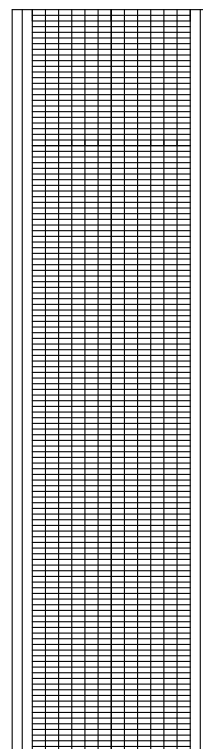
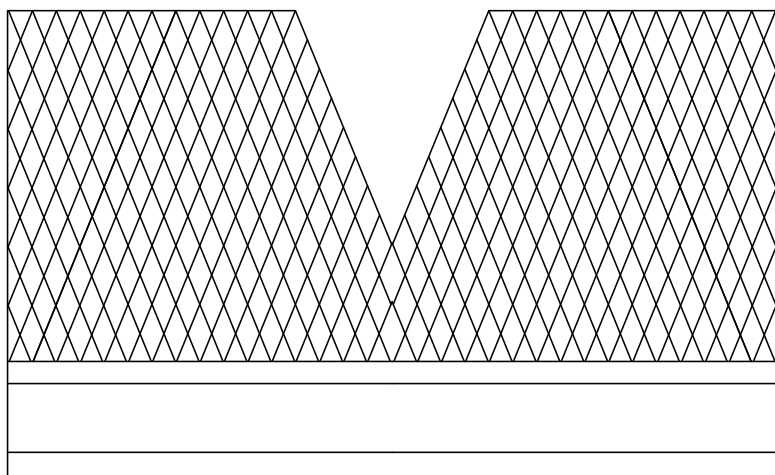

Madera, metal, hueso

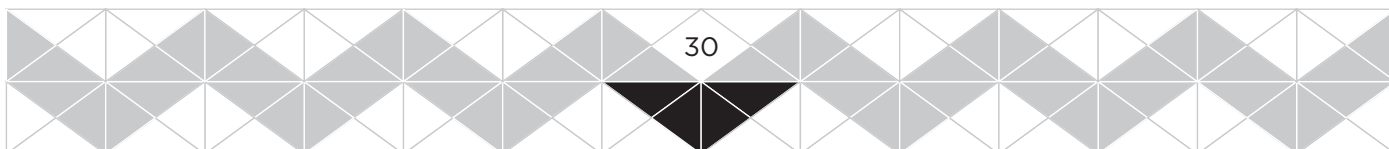
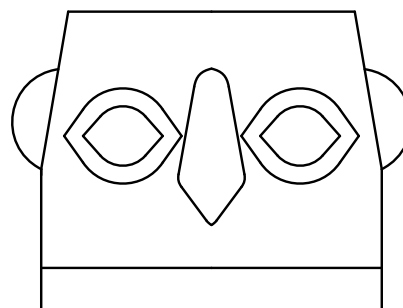
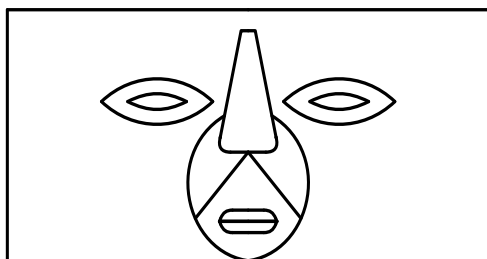

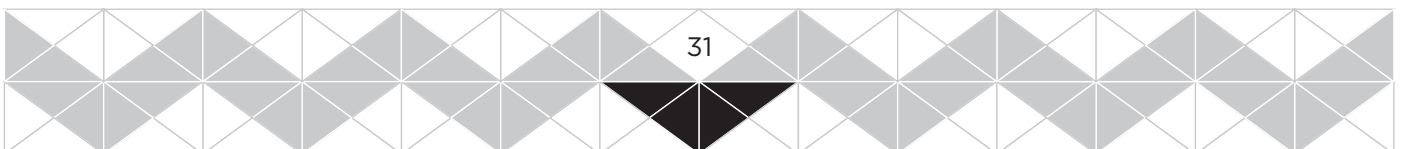
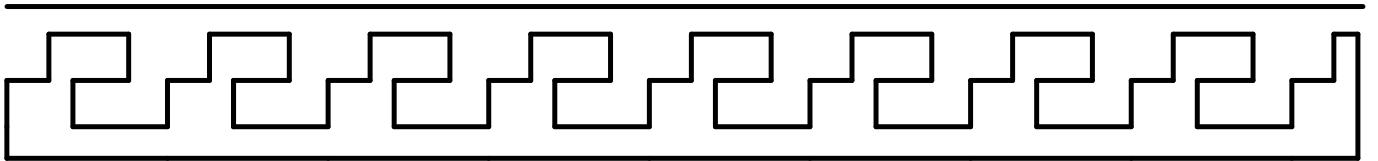
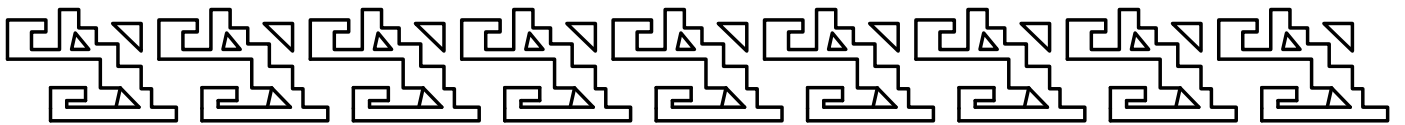
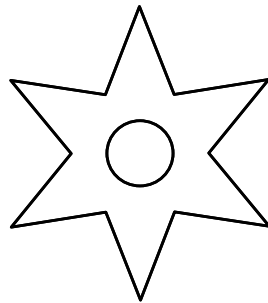
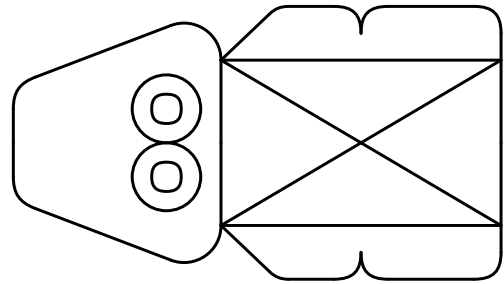
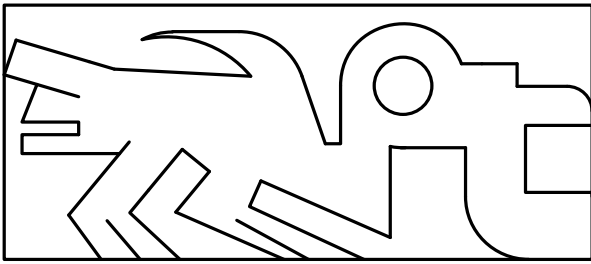

Periodo Colonial

ARQUITECTURA CIVIL HUAMANGA

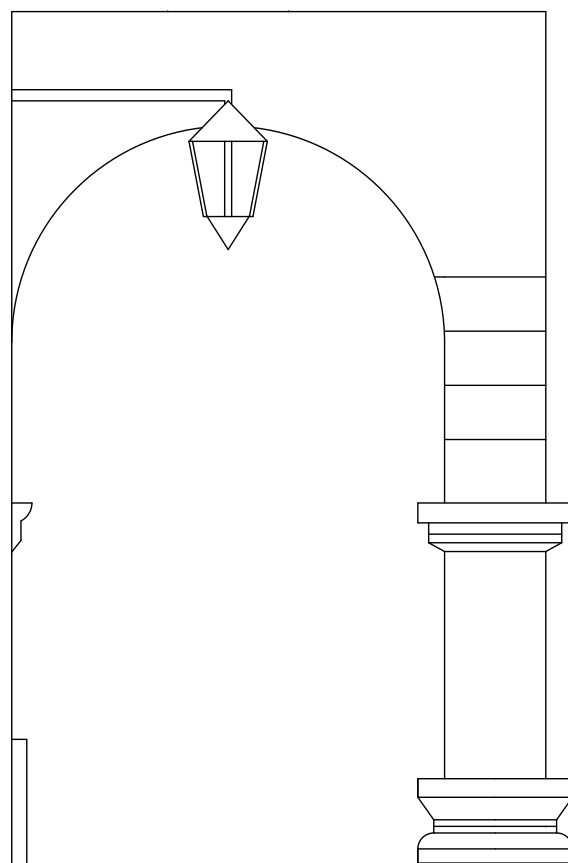
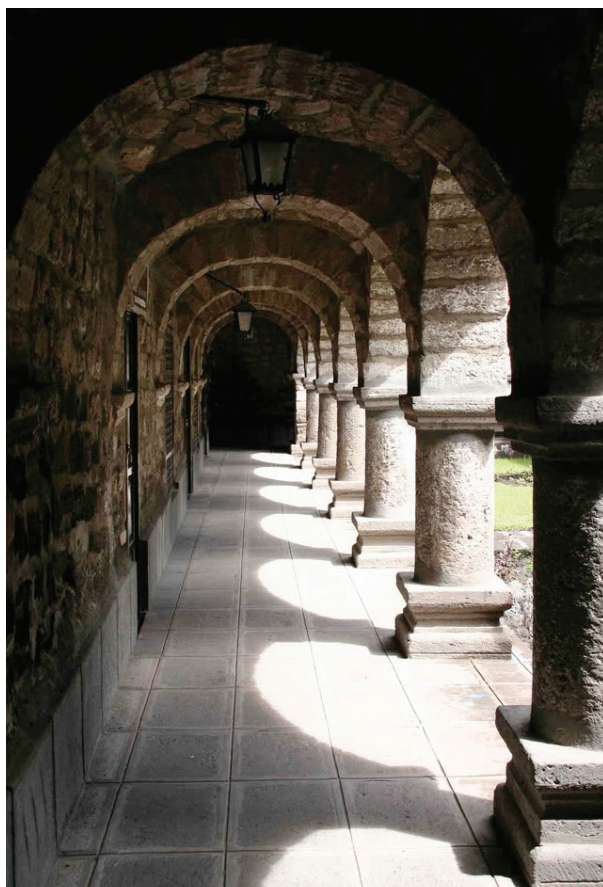

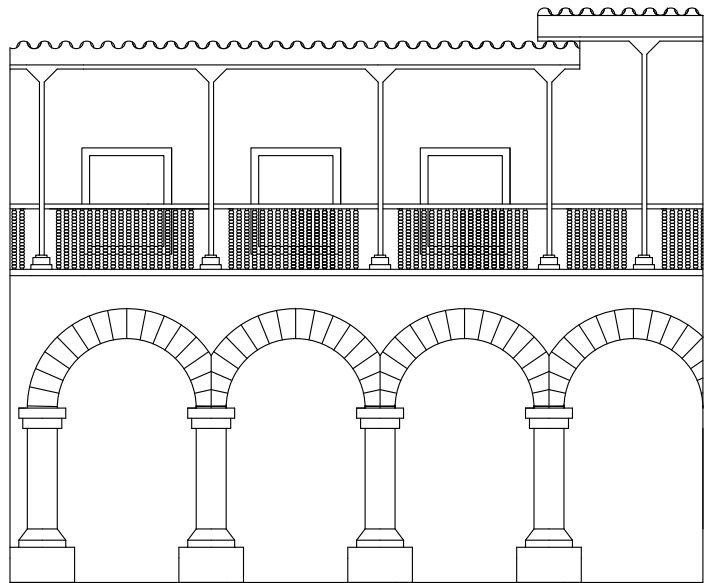
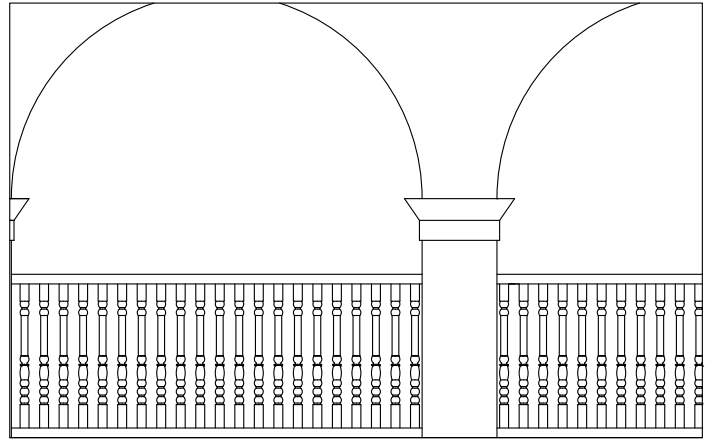

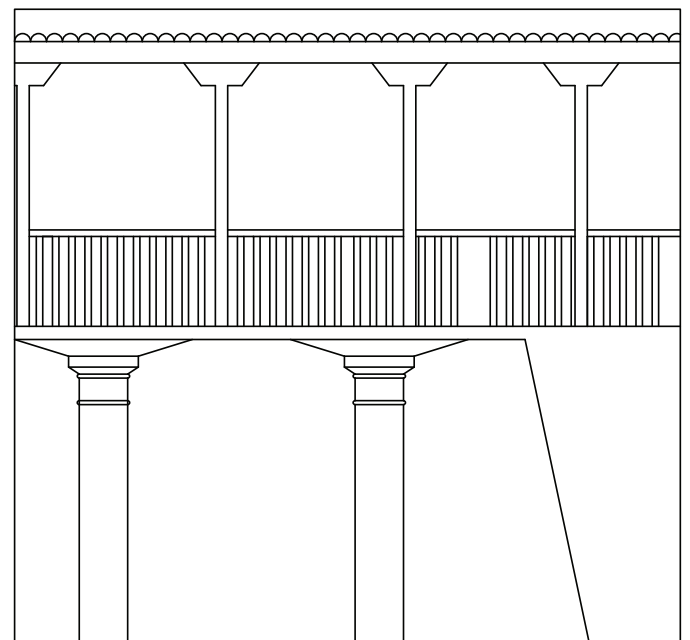
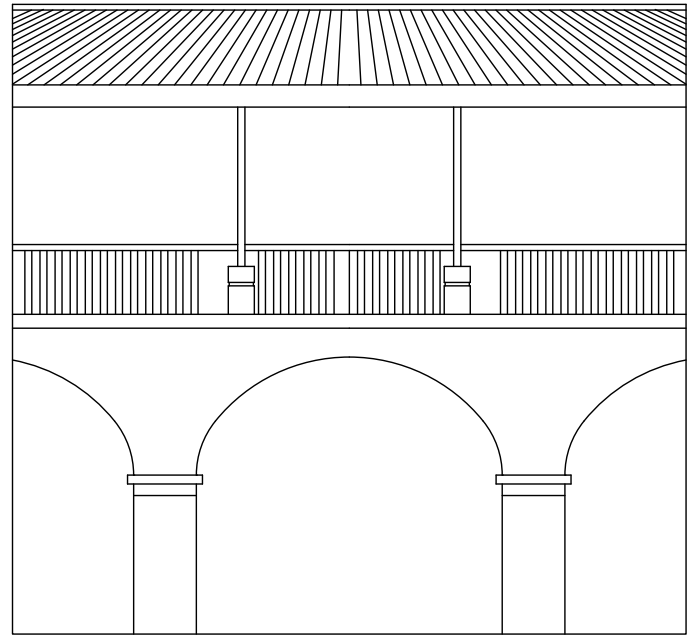

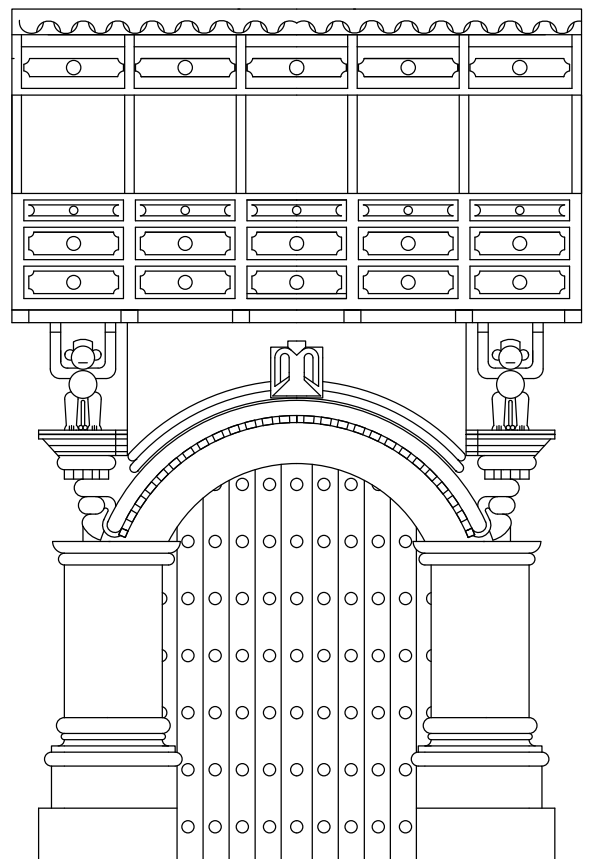
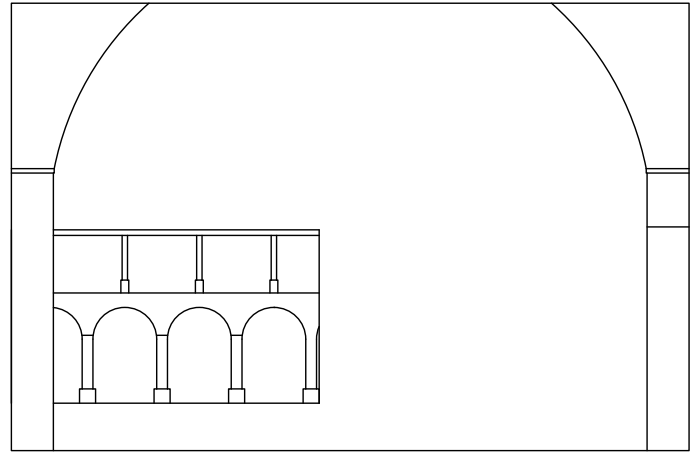

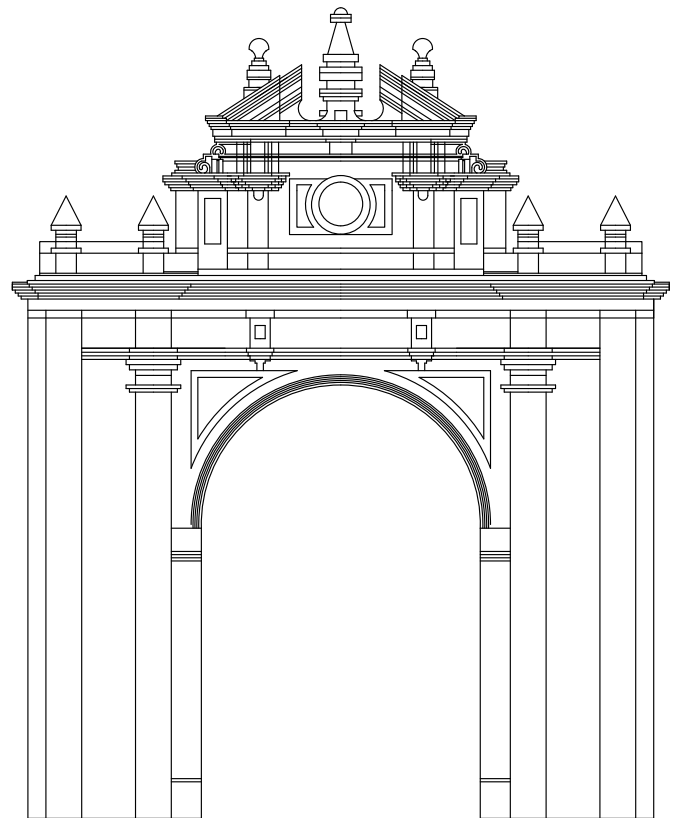
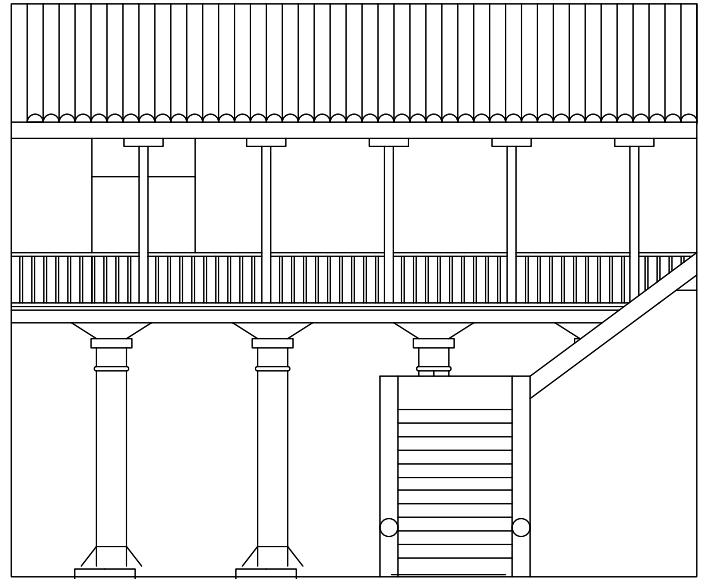

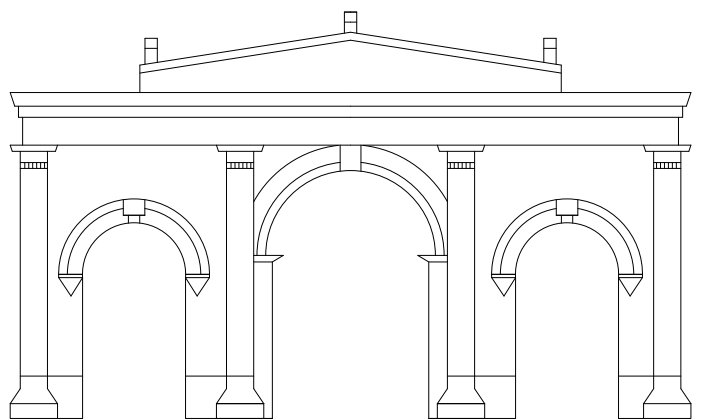
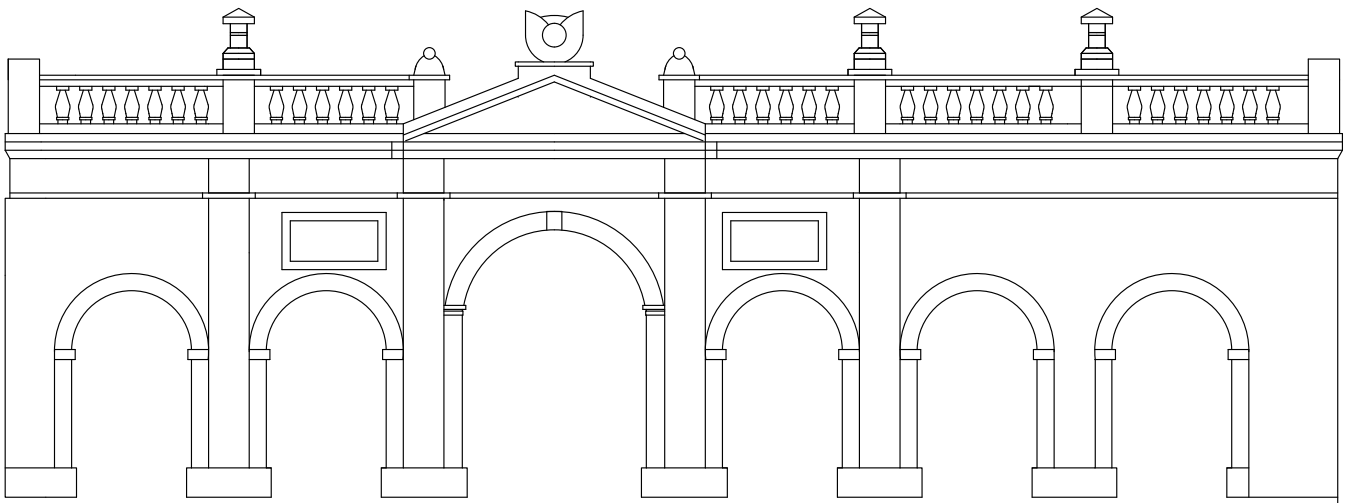

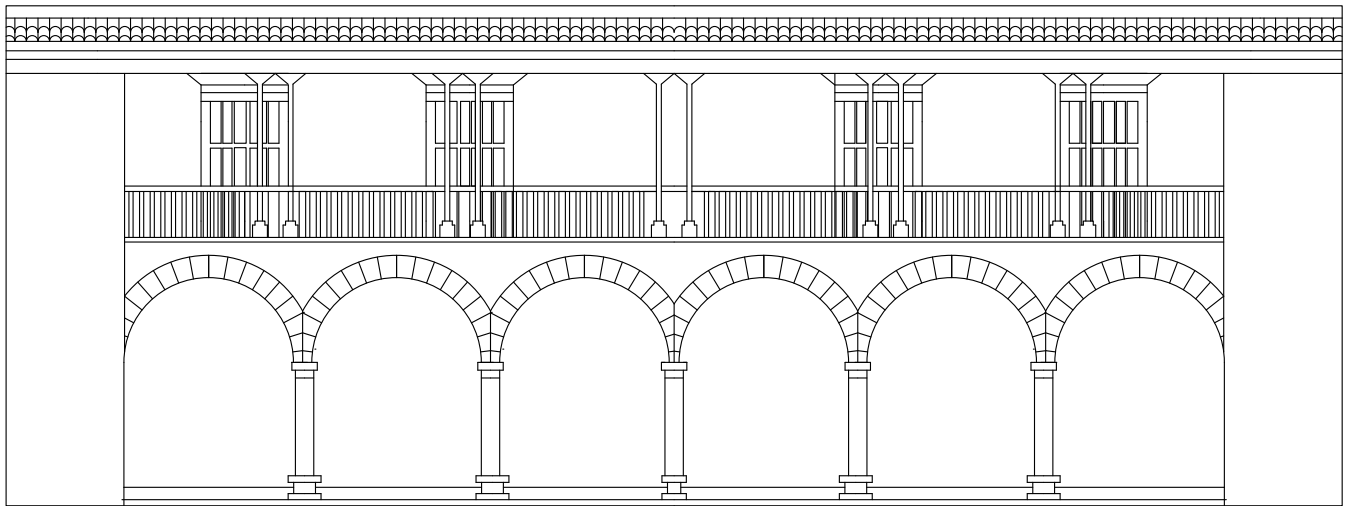

Periodo Colonial

ARQUITECTURA RELIGIOSA HUAMANGA



Catedral

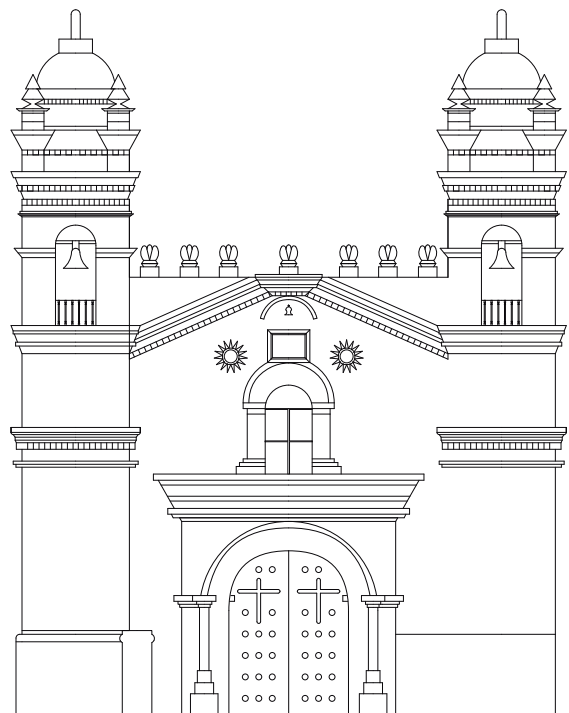
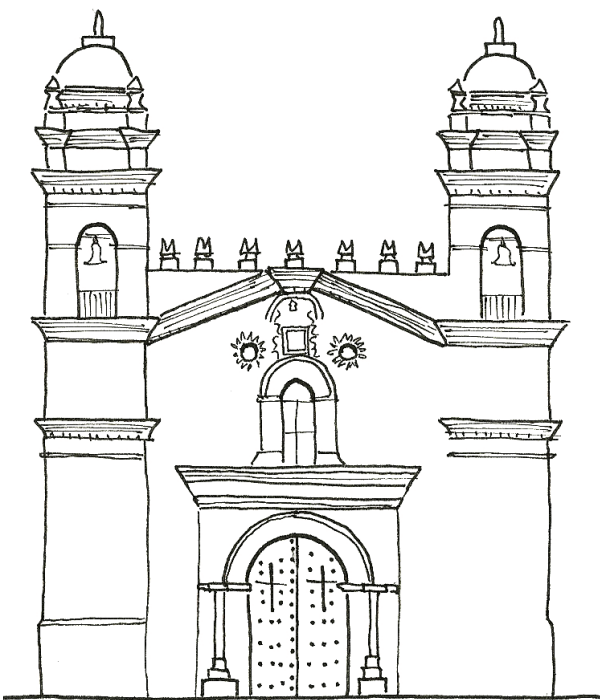

Templo de La Buena Muerte

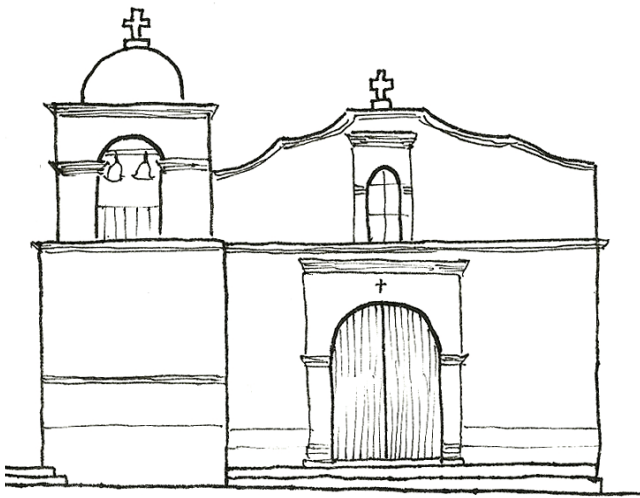

Templo El Calvario

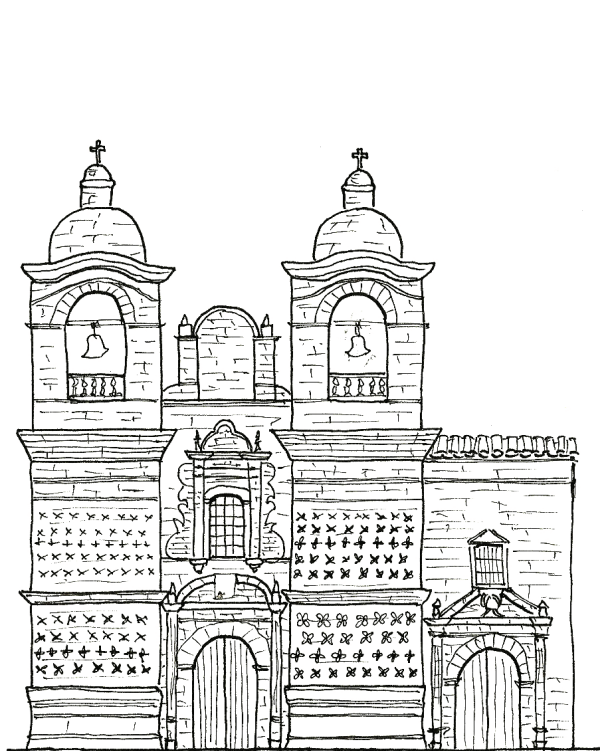
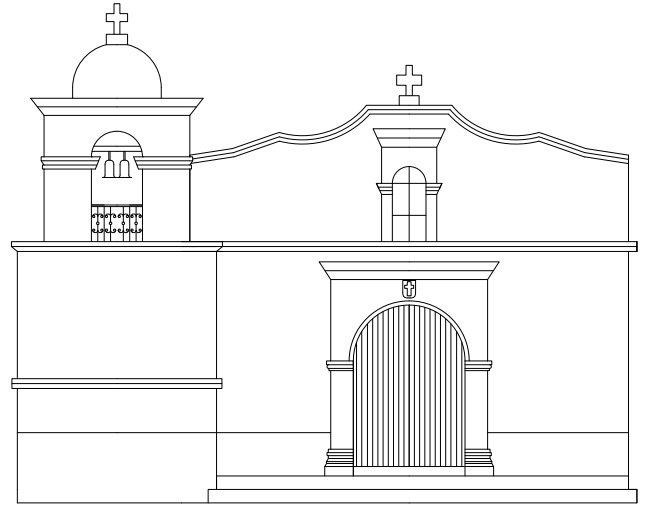

Templo de La Compañía de Jesús

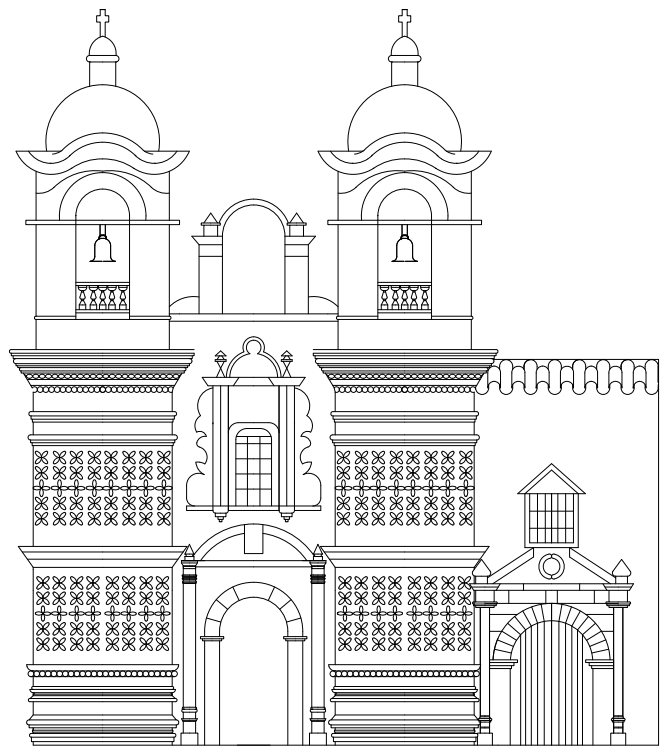

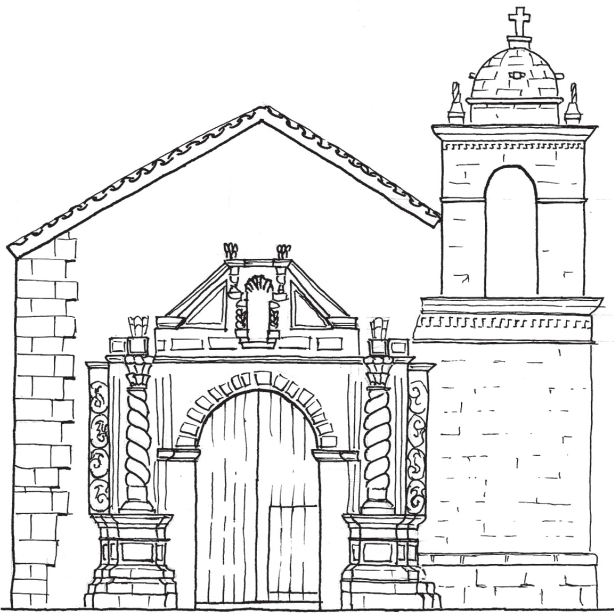

Iglesia Pampa de San Agustín

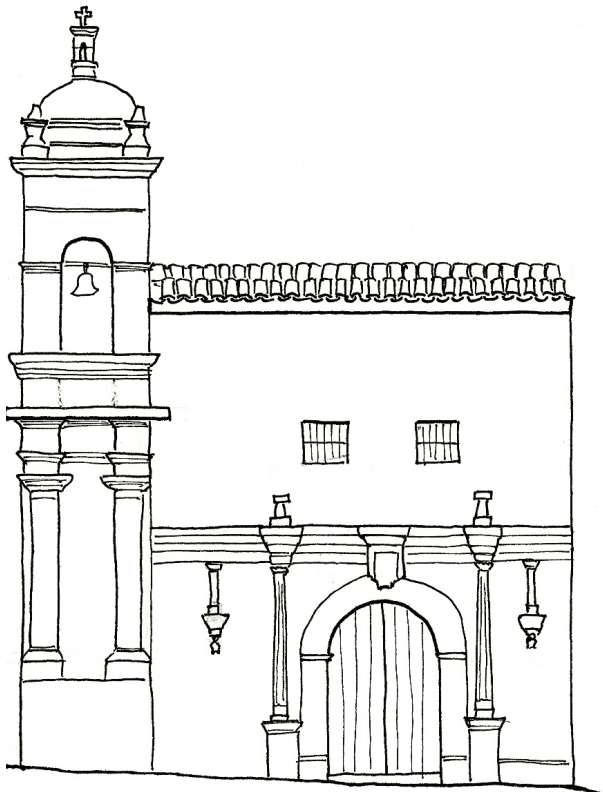
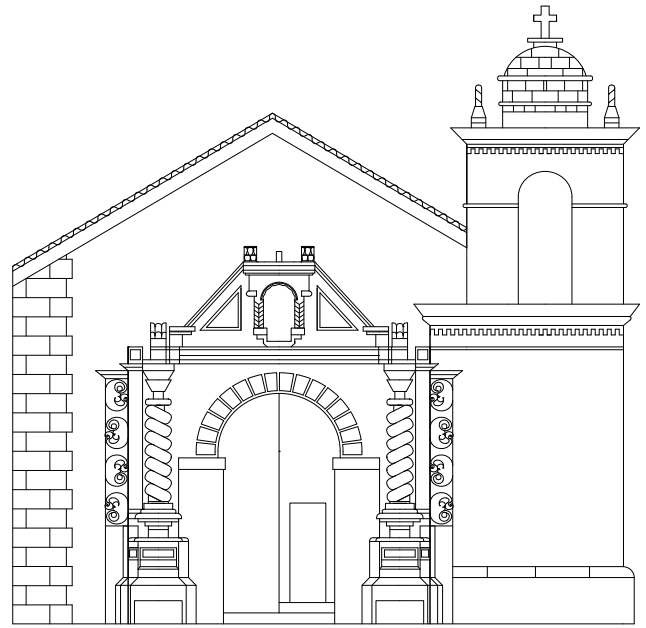

Templo de La Merced

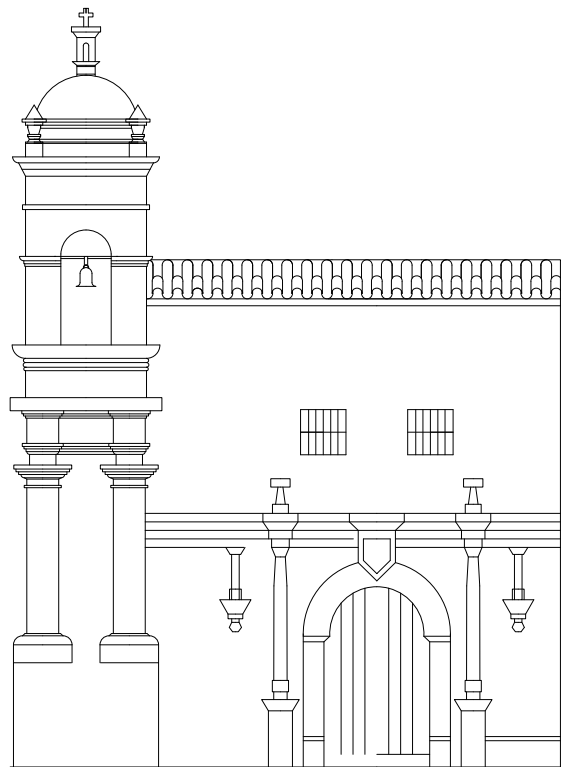

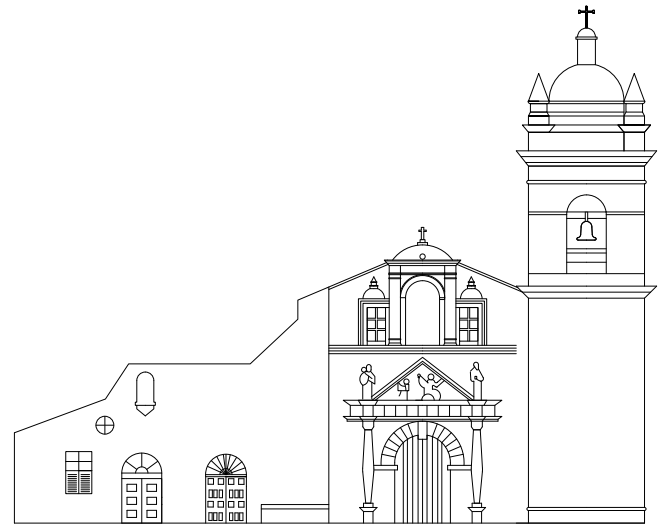

Iglesia de San Francisco de Asis

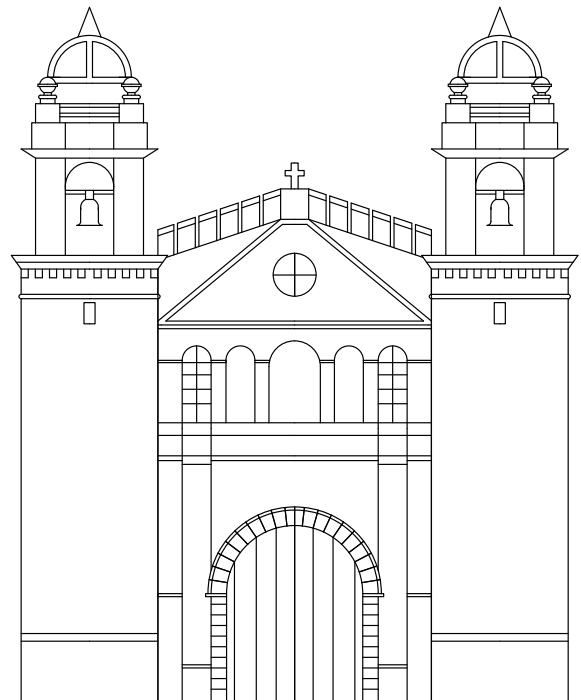
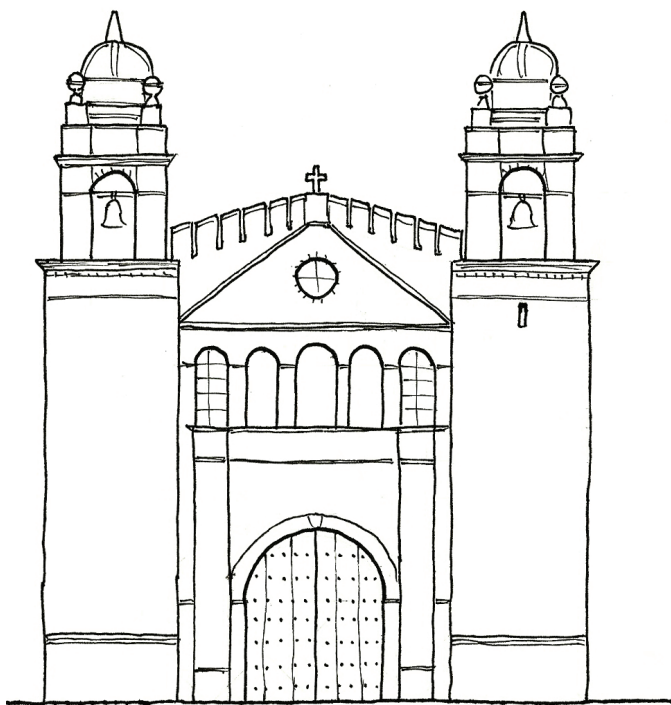

Iglesia de San Agustin



Iglesia San Juan de Dios

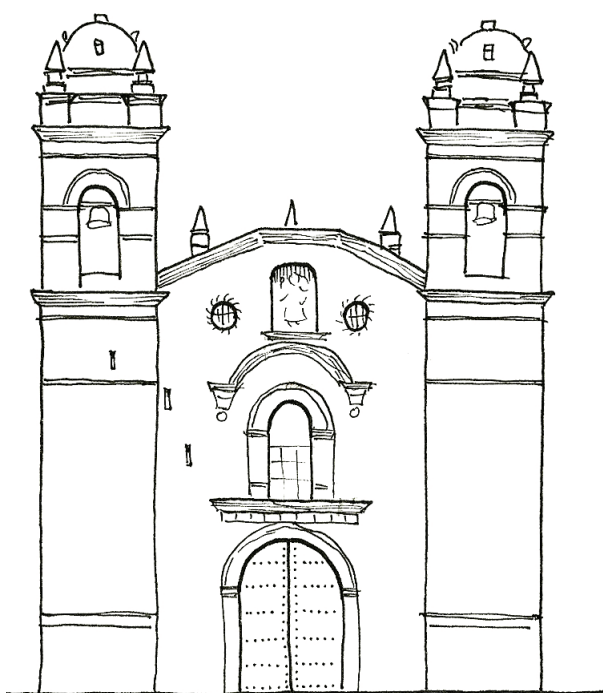
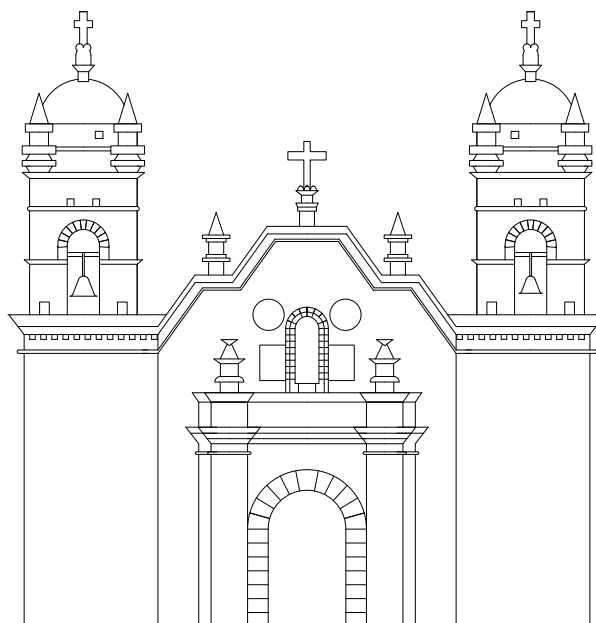

Iglesia de San Francisco de Paula

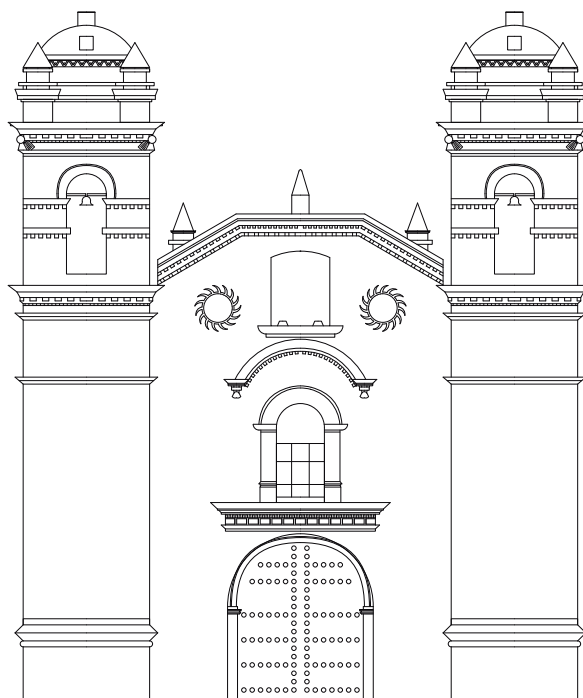

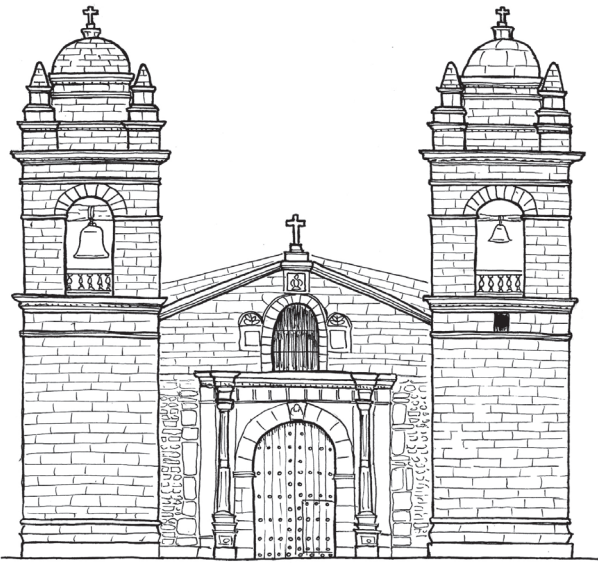

Iglesia de Santa Ana

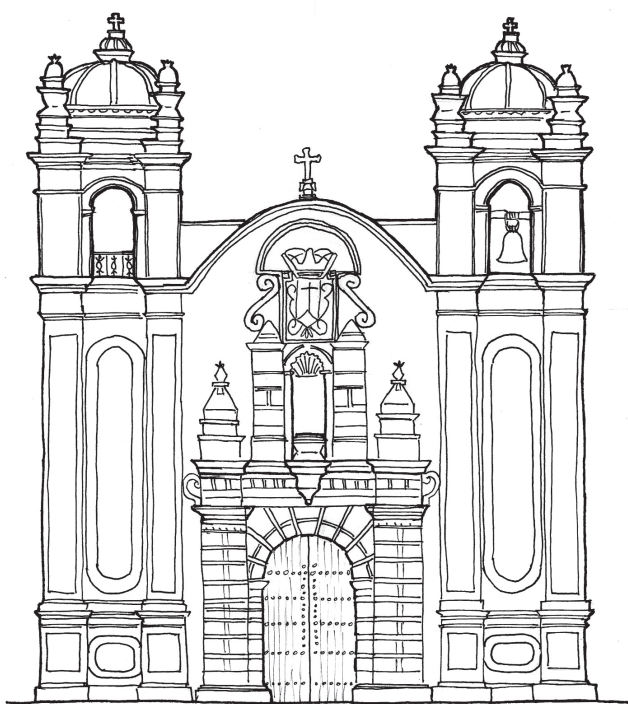

Iglesia de Santa Teresa

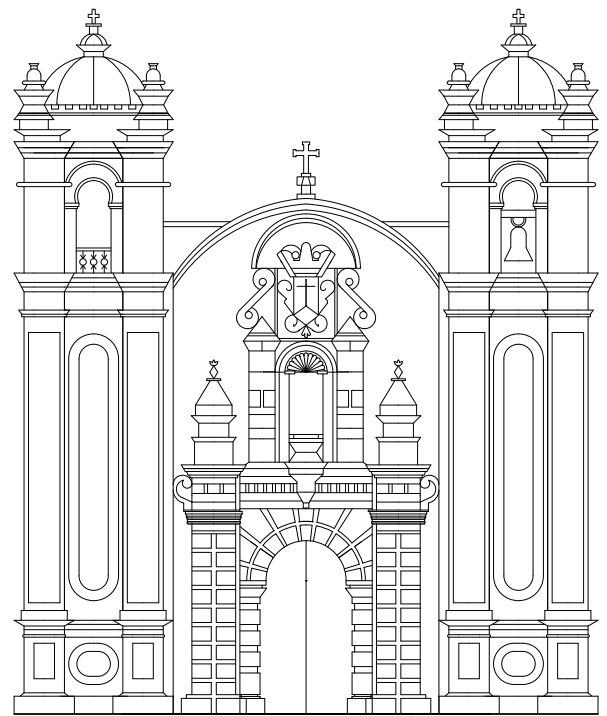

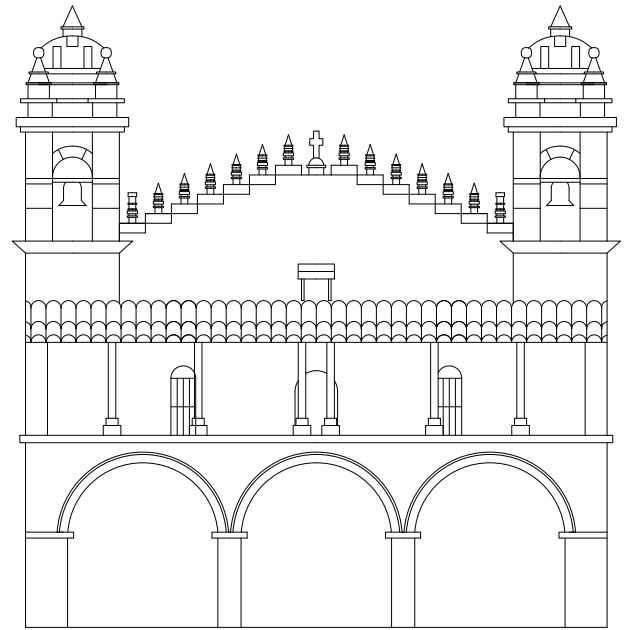
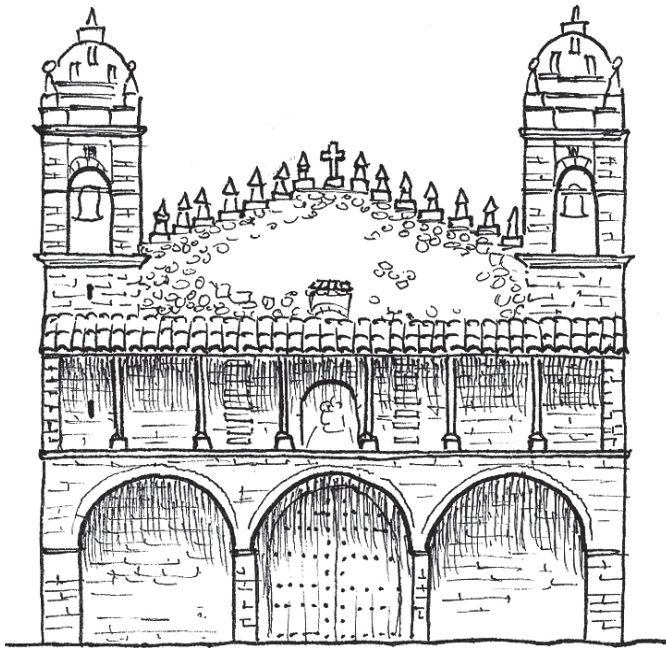

motivo: aves míticas
dimensiones: 175

Detalles de fachadas

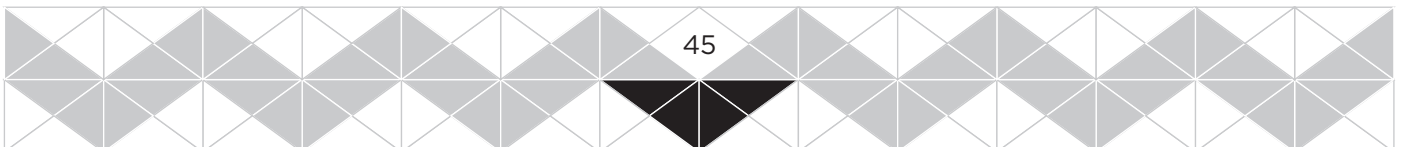
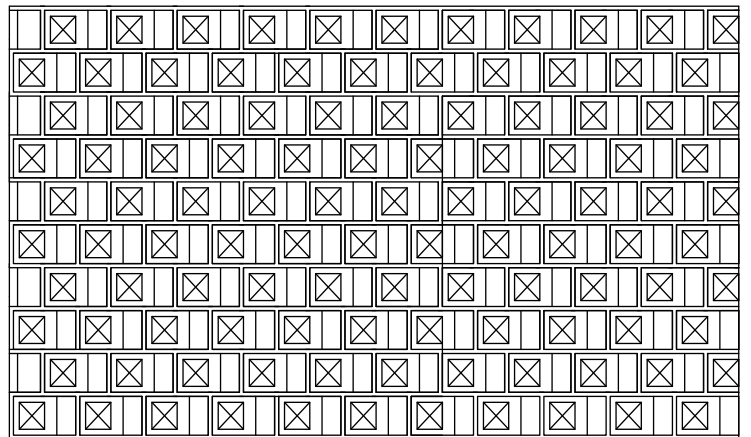
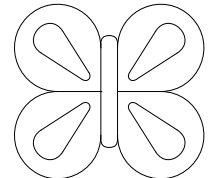
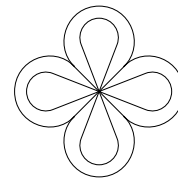
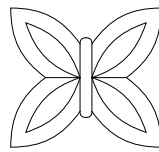
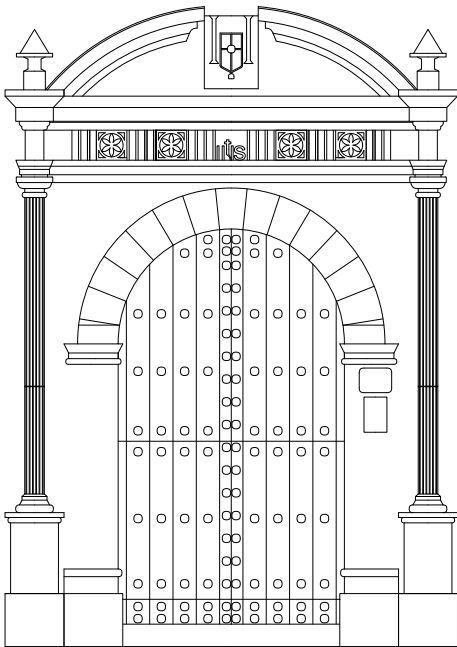

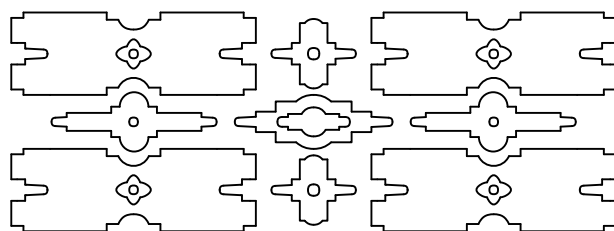
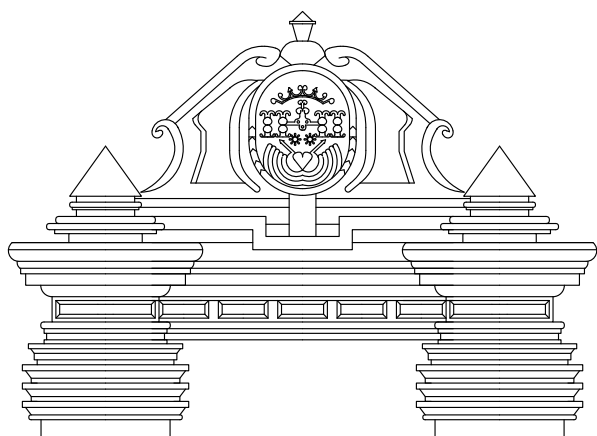
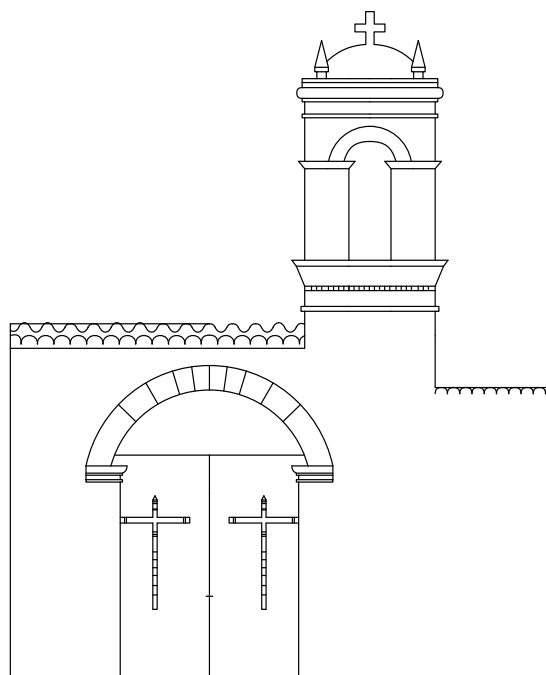
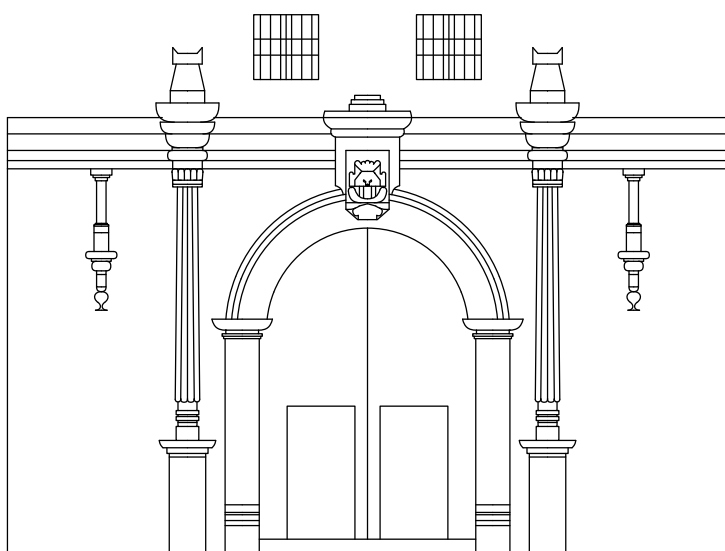
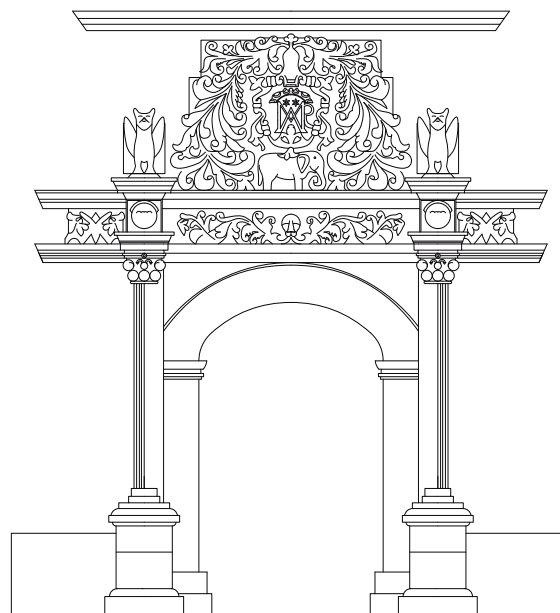

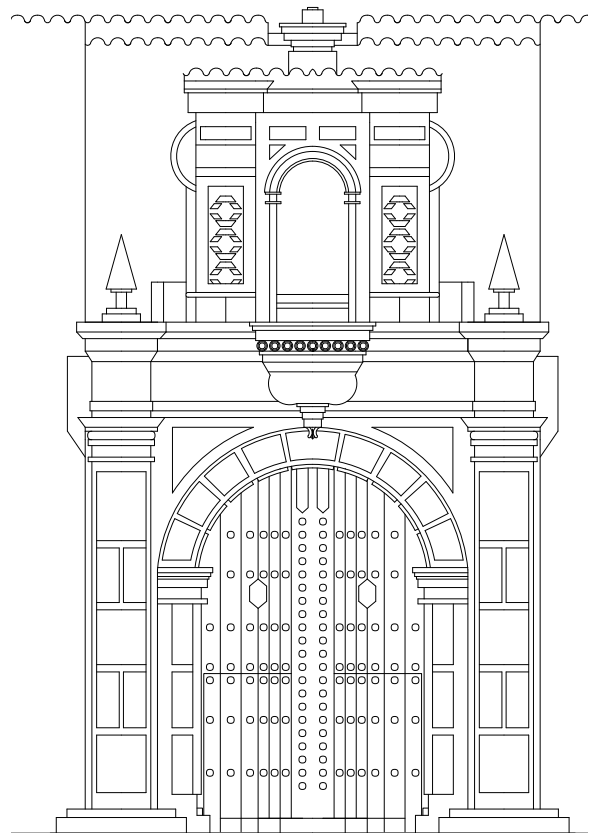
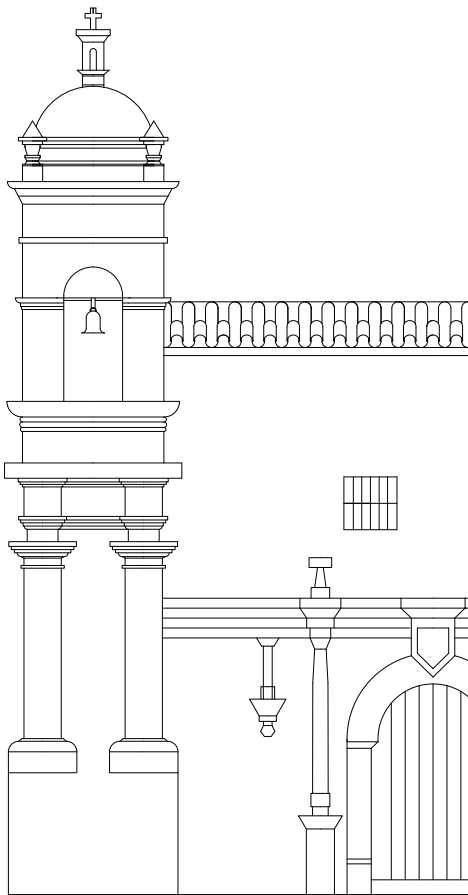
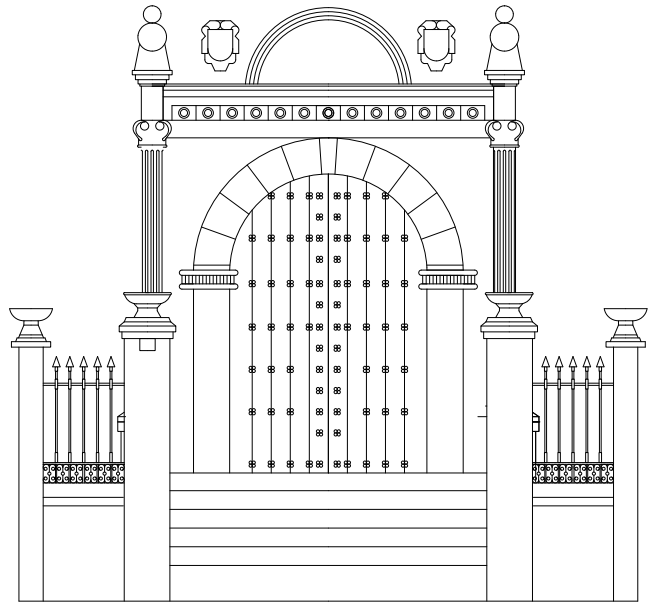
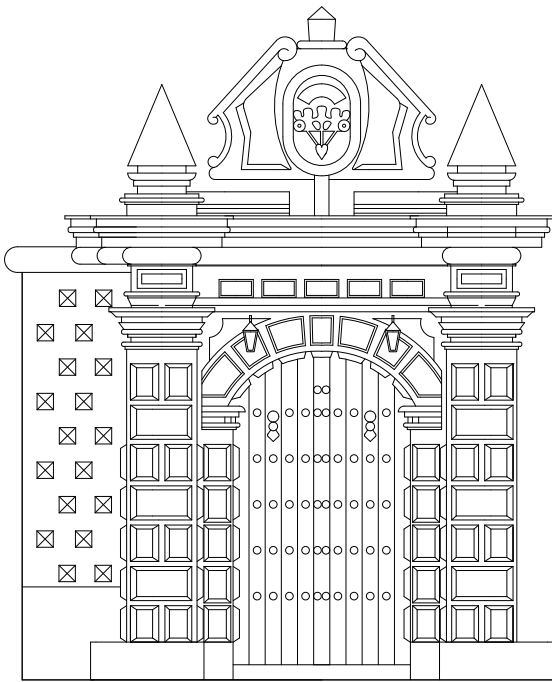

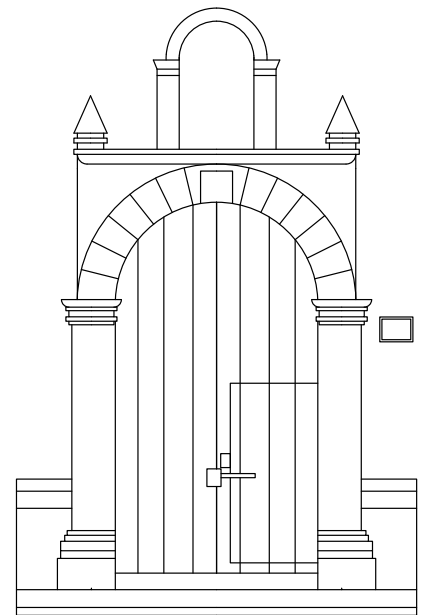
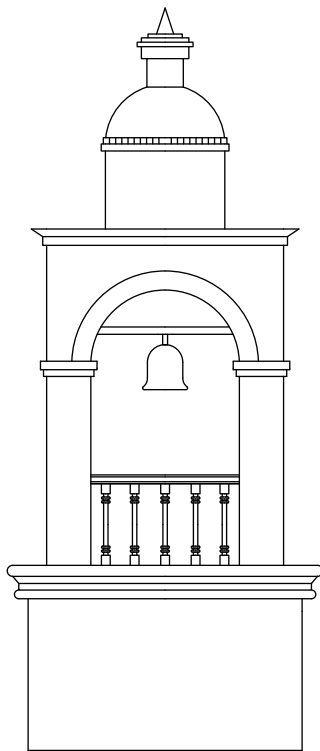
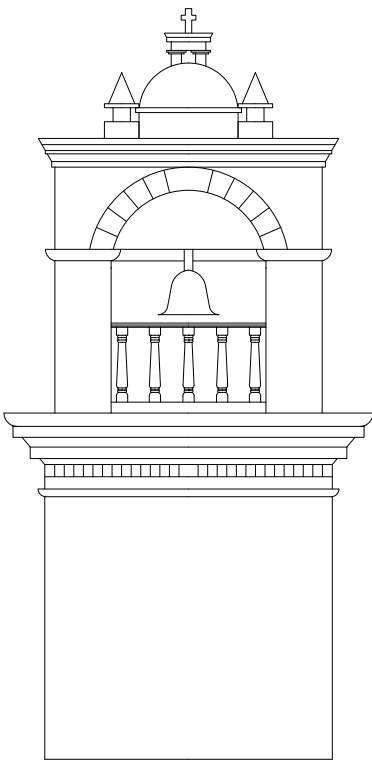
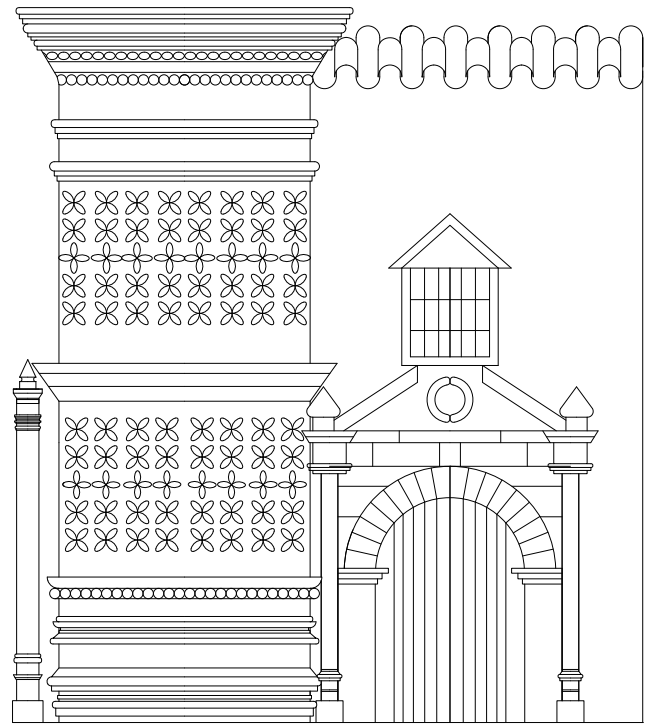
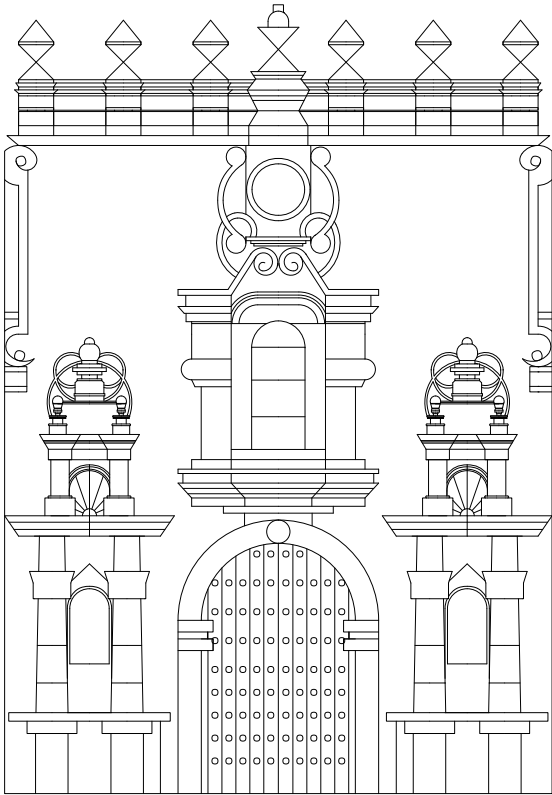

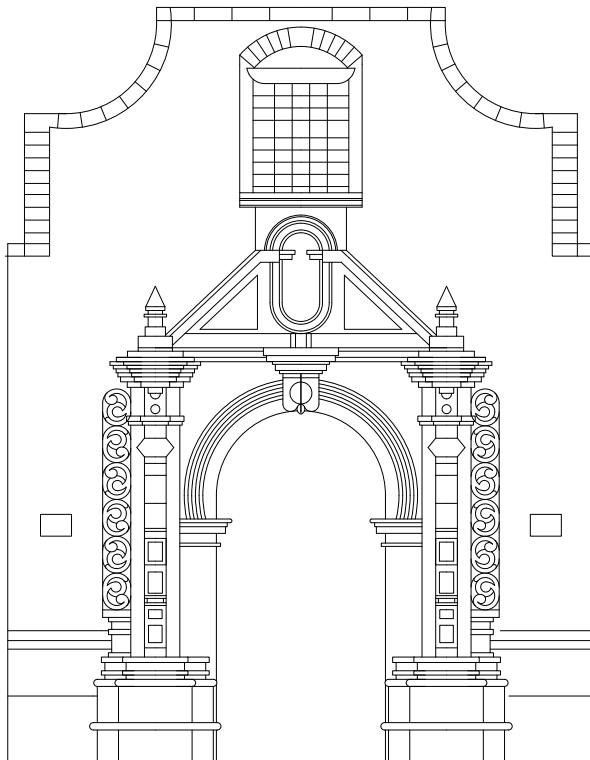
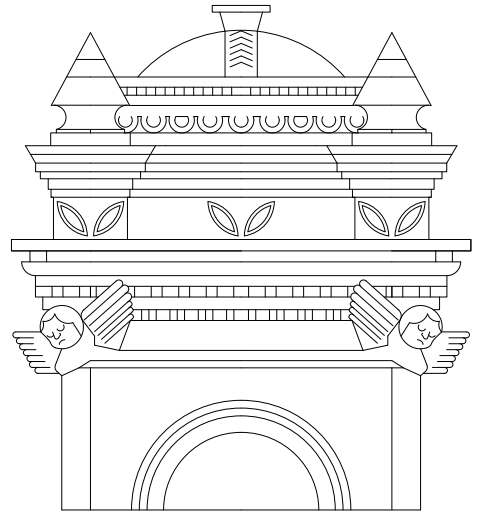
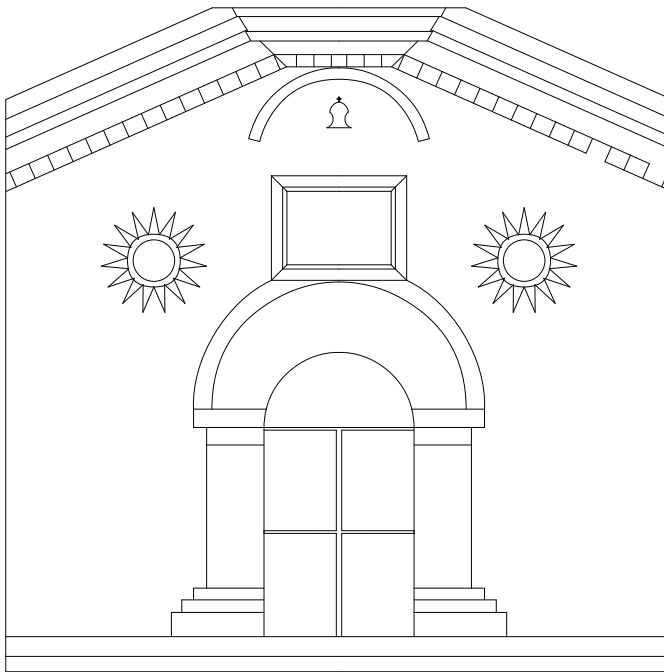

Naturaleza

PAMPA DE LA QUINUA

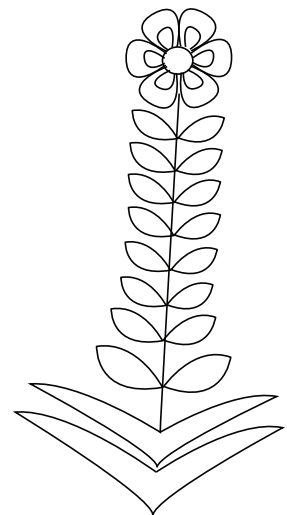
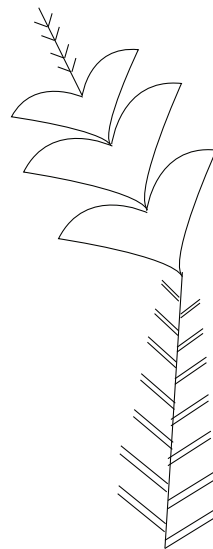
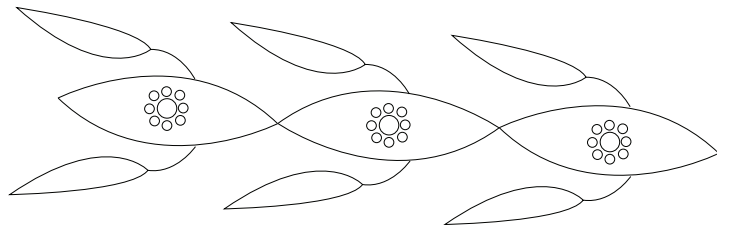
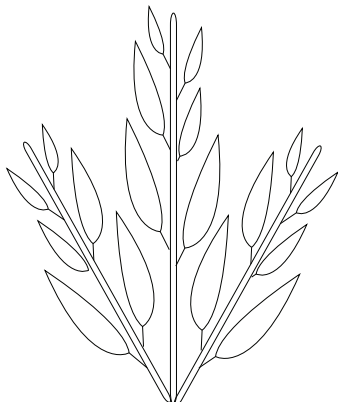
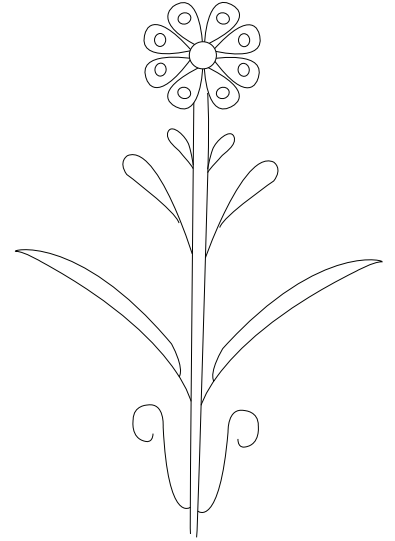
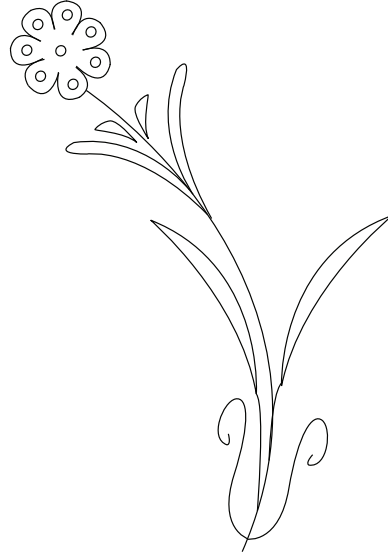

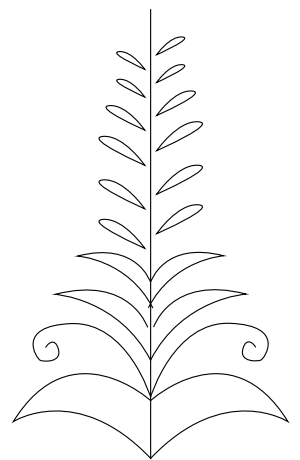
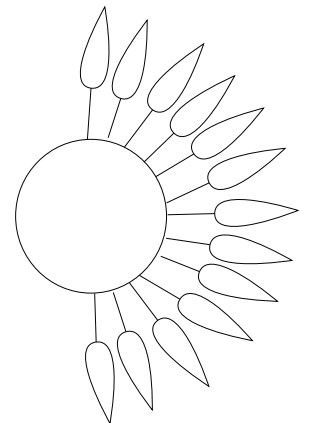
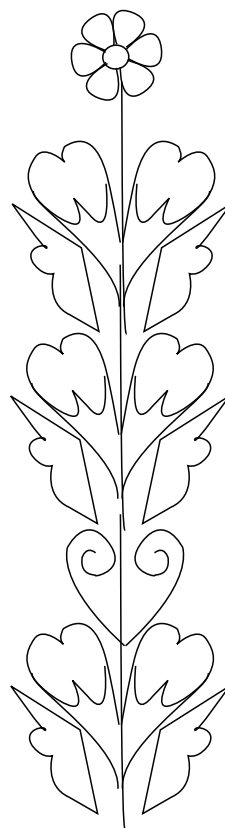
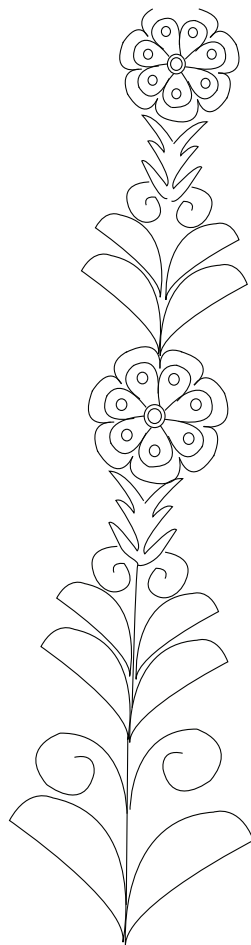
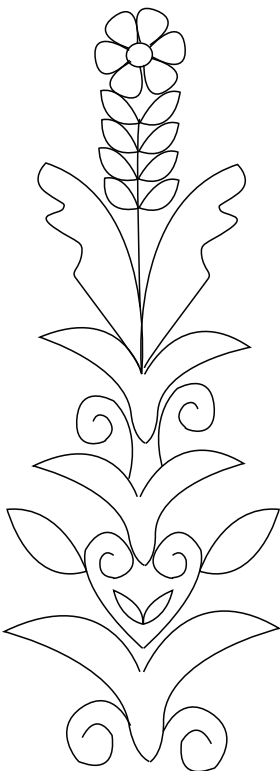
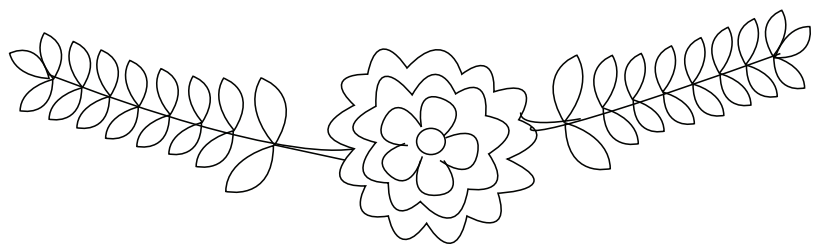
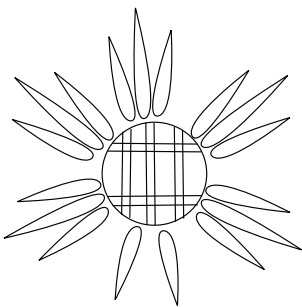
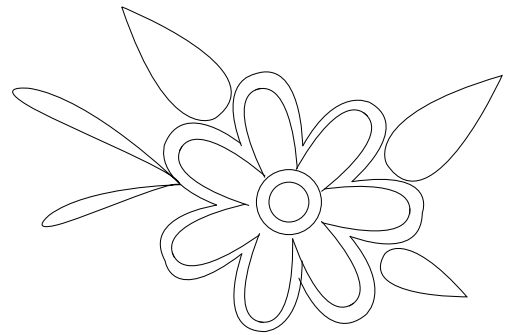
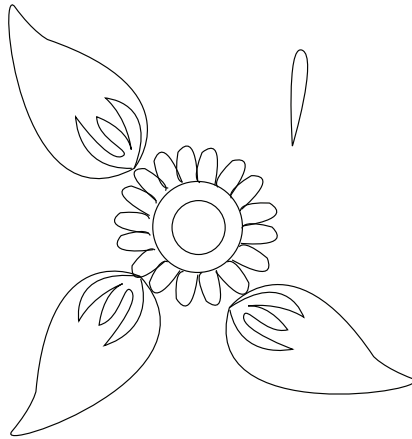
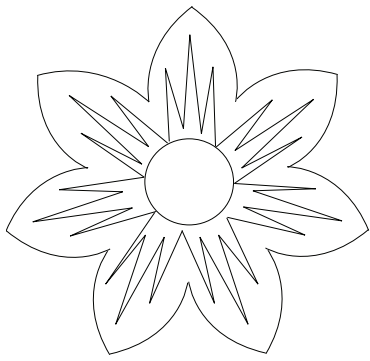

BIBLIOGRAFÍA

Fuentes bibliográficas empleadas

COOK~ Anita Gwynn 1994. Wari y Tiwanaku : entre el estilo y la imagen. Lima: Fondo Editorial~ PUCP

FUNDACIÓN EL MONTE (España) 2000. Wari: Arte precolombino peruano. Sevilla : Centro Cultural El Monte [Lima] : INC. Museo Nacional de Arqueología~ Antropología e Historia del Perú

MENZEL~ Dorothy 1968. La cultura Huari. Lima: Compañía de Seguros y Reaseguros Peruano-Suiza.

LA VALLE~ José Antonio y Otros~ 1990. Huari~ Colección arte y tesoros del Perú. Lima: Banco de Crédito del Perú.

REID~ William 1984. Culturas precolombinas: Huari. Lima: Banco de Crédito del Perú.

WEB:

Catálogo del Museo Larca en:

<http://www.museolarco.org/catalogol>

Registro de imágenes en fuentes primarias:

o Museo de Sitio de Puruchuco

o Museo de Sitio de Pachacamac

o Museo Nacional de Arqueología~ Antropología e Historia.